

DDR SDRAM REGISTERED DIMM

MT18VDDT3272 – 256MB
MT18VDDT6472 – 512MB
MT18VDDT12872 – 1GB
MT18VDDT25672 – 2GB

For the latest data sheet, please refer to the Micron® Web site: www.micron.com/products/modules

Features

- 184-pin, dual in-line memory module (DIMM)
- Fast data transfer rates: PC1600 or PC2100
- Utilizes 200 MT/s, 266 MT/s DDR SDRAM components
- Registered inputs with one-clock delay
- Phase-lock loop (PLL) clock driver to reduce loading
- Supports ECC error detection and correction
- 256MB (32 Meg x 72), 512MB (64 Meg x 72), 1GB (128 Meg x 72), or 2GB (256 Meg x 72)
- VDD = VDDQ = +2.5V
- VDDSPD = +2.3V to +3.6V
- 2.5V I/O (SSTL_2 compatible)
- Commands entered on each positive CK edge
- DQS edge-aligned with data for READs; center-aligned with data for WRITEs
- Internal, pipelined double data rate (DDR) architecture; two data accesses per clock cycle
- Bidirectional data strobe (DQS) transmitted/received with data—i.e., source-synchronous data capture
- Differential clock inputs CK and CK#
- Four internal device banks for concurrent operation
- Programmable burst lengths: 2, 4, or 8
- Auto precharge option
- Auto Refresh and Self Refresh Modes
- 15.625µs (256MB), 7.8125µs (512MB, 1GB, and 2GB) maximum average periodic refresh interval
- Serial Presence Detect (SPD) with EEPROM
- Programmable READ CAS latency
- Gold edge contacts

Figure 1: 184-Pin DIMM (MO-206)

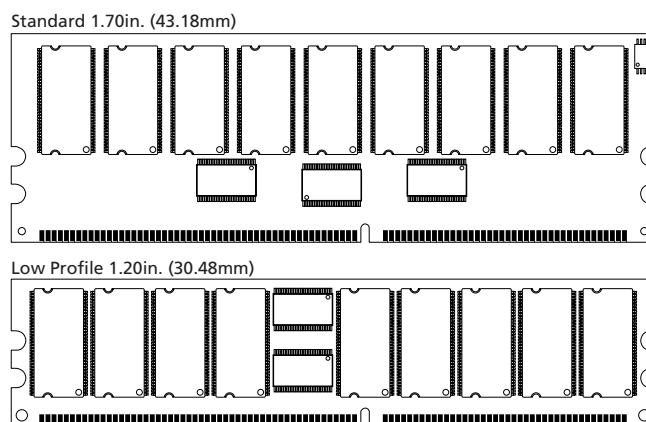

OPTIONS

- Package
 - 184-pin DIMM (standard) G
 - 184-pin DIMM (lead-free)¹ Y
- Memory clock/Speed, CAS Latency²
 - 7.5ns (133 MHz) 266 MT/s, CL = 2 -262¹
 - 7.5ns (133 MHz) 266 MT/s, CL = 2 -26A¹
 - 7.5ns (133 MHz) 266 MT/s, CL = 2.5 -265
 - 10ns (100 MHz) 200 MT/s, CL = 2 -202
- PCB
 - Standard 1.75in. (44.45mm) See Table 2 note
 - Low-Profile 1.20in. (30.48mm) See Table 2 note

MARKING

NOTE: 1. Contact Micron for product availability.
 2. CL = CAS (READ) latency; registered mode adds one clock cycle to CL.

Table 1: Address Table

	256MB	512MB	1GB	2GB
Refresh Count	4K	8K	8K	8K
Row Addressing	4K (A0–A11)	8K (A0–A12)	8K (A0–A12)	16K (A0–A13)
Device Bank Addressing	4 (BA0, BA1)	4 (BA0, BA1)	4 (BA0, BA1)	4 (BA0, BA1)
Device Configuration	128Mb (32 Meg x 4)	256Mb (64 Meg x 4)	512Mb (128 Meg x 4)	1Gb (256 Meg x 4)
Column Addressing	2K (A0–A9, A11)	2K (A0–A9, A11)	4K (A0–A9, A11, A12)	4K (A0–A9, A11, A12)
Module Rank Addressing	1 (S0#)	1 (S0#)	1 (S0#)	1 (S0#)



Table 2: Part Numbers and Timing Parameters

PART NUMBER ¹	MODULE DENSITY	CONFIGURATION	MODULE BANDWIDTH	MEMORY CLOCK/ DATA RATE	LATENCY (CL - t _{RCD} - t _{RP})
MT18VDDT3272G-262__	256MB	32 Meg x 72	2.1 GB/s	7.5ns/266 MT/s	2-2-2
MT18VDDT3272Y-262__	256MB	32 Meg x 72	2.1 GB/s	7.5ns/266 MT/s	2-2-2
MT18VDDT3272G-26A__	256MB	32 Meg x 72	2.1 GB/s	7.5ns/266 MT/s	2-3-3
MT18VDDT3272Y-26A__	256MB	32 Meg x 72	2.1 GB/s	7.5ns/266 MT/s	2-3-3
MT18VDDT3272G-265__	256MB	32 Meg x 72	2.1 GB/s	7.5ns/266 MT/s	2.5-3-3
MT18VDDT3272Y-265__	256MB	32 Meg x 72	2.1 GB/s	7.5ns/266 MT/s	2.5-3-3
MT18VDDT3272G-202__	256MB	32 Meg x 72	1.6 GB/s	10ns/200 MT/s	2-2-2
MT18VDDT3272Y-202__	256MB	32 Meg x 72	1.6 GB/s	10ns/200 MT/s	2-2-2
MT18VDDT6472G-262__	512MB	64 Meg x 72	2.1 GB/s	7.5ns/266 MT/s	2-2-2
MT18VDDT6472Y-262__	512MB	64 Meg x 72	2.1 GB/s	7.5ns/266 MT/s	2-2-2
MT18VDDT6472G-26A__	512MB	64 Meg x 72	2.1 GB/s	7.5ns/266 MT/s	2-3-3
MT18VDDT6472Y-26A__	512MB	64 Meg x 72	2.1 GB/s	7.5ns/266 MT/s	2-3-3
MT18VDDT6472G-265__	512MB	64 Meg x 72	2.1 GB/s	7.5ns/266 MT/s	2.5-3-3
MT18VDDT6472Y-265__	512MB	64 Meg x 72	2.1 GB/s	7.5ns/266 MT/s	2.5-3-3
MT18VDDT6472G-202__	512MB	64 Meg x 72	1.6 GB/s	10ns/200 MT/s	2-2-2
MT18VDDT6472Y-202__	512MB	64 Meg x 72	1.6 GB/s	10ns/200 MT/s	2-2-2
MT18VDDT12872G-262__	1GB	128 Meg x 72	2.1 GB/s	7.5ns/266 MT/s	2-2-2
MT18VDDT12872Y-262__	1GB	128 Meg x 72	2.1 GB/s	7.5ns/266 MT/s	2-2-2
MT18VDDT12872G-26A__	1GB	128 Meg x 72	2.1 GB/s	7.5ns/266 MT/s	2-3-3
MT18VDDT12872Y-26A__	1GB	128 Meg x 72	2.1 GB/s	7.5ns/266 MT/s	2-3-3
MT18VDDT12872G-265__	1GB	128 Meg x 72	2.1 GB/s	7.5ns/266 MT/s	2.5-3-3
MT18VDDT12872Y-265__	1GB	128 Meg x 72	2.1 GB/s	7.5ns/266 MT/s	2.5-3-3
MT18VDDT12872G-202__	1GB	128 Meg x 72	1.6 GB/s	10ns/200 MT/s	2-2-2
MT18VDDT12872Y-202__	1GB	128 Meg x 72	1.6 GB/s	10ns/200 MT/s	2-2-2
MT18VDDT25672G-262__ ²	2GB	256 Meg x 72	2.1 GB/s	7.5ns/266 MT/s	2-2-2
MT18VDDT25672Y-262__ ²	2GB	256 Meg x 72	2.1 GB/s	7.5ns/266 MT/s	2-2-2
MT18VDDT25672G-26A__ ²	2GB	256 Meg x 72	2.1 GB/s	7.5ns/266 MT/s	2-3-3
MT18VDDT25672Y-26A__ ²	2GB	256 Meg x 72	2.1 GB/s	7.5ns/266 MT/s	2-3-3
MT18VDDT25672G-265__ ²	2GB	256 Meg x 72	2.1 GB/s	7.5ns/266 MT/s	2.5-3-3
MT18VDDT25672Y-265__ ²	2GB	256 Meg x 72	2.1 GB/s	7.5ns/266 MT/s	2.5-3-3
MT18VDDT25672G-202__ ²	2GB	256 Meg x 72	1.6 GB/s	10ns/200 MT/s	2-2-2
MT18VDDT25672Y-202__ ²	2GB	256 Meg x 72	1.6 GB/s	10ns/200 MT/s	2-2-2

NOTE:

1. All part numbers end with a two-place code (not shown), designating component and PCB revisions. Consult factory for current revision codes. Example: MT18VDDT6472G-265B1.
2. Contact Micron for product availability.

Table 3: Pin Assignment (184-Pin DIMM Front)

PIN	SYMBOL	PIN	SYMBOL	PIN	SYMBOL	PIN	SYMBOL
1	VREF	24	DQ17	47	DQS8	70	VDD
2	DQ0	25	DQS2	48	A0	71	NC
3	Vss	26	Vss	49	CB2	72	DQ48
4	DQ1	27	A9	50	Vss	73	DQ49
5	DQS0	28	DQ18	51	CB3	74	Vss
6	DQ2	29	A7	52	BA1	75	NC
7	VDD	30	VDDQ	53	DQ32	76	NC
8	DQ3	31	DQ19	54	VDDQ	77	VDDQ
9	NC	32	A5	55	DQ33	78	DQS6
10	RESET#	33	DQ24	56	DQS4	79	DQ50
11	Vss	34	Vss	57	DQ34	80	DQ51
12	DQ8	35	DQ25	58	Vss	81	Vss
13	DQ9	36	DQS3	59	BA0	82	NC
14	DQS1	37	A4	60	DQ35	83	DQ56
15	VDDQ	38	VDD	61	DQ40	84	DQ57
16	NC	39	DQ26	62	VDDQ	85	VDD
17	NC	40	DQ27	63	WE#	86	DQS7
18	Vss	41	A2	64	DQ41	87	DQ58
19	DQ10	42	Vss	65	CAS#	88	DQ59
20	DQ11	43	A1	66	Vss	89	Vss
21	CKE0	44	CB0	67	DQS5	90	NC
22	VDDQ	45	CB1	68	DQ42	91	SDA
23	DQ16	46	VDD	69	DQ43	92	SCL

Table 4: Pin Assignment (184-Pin DIMM Back)

PIN	SYMBOL	PIN	SYMBOL	PIN	SYMBOL	PIN	SYMBOL
93	Vss	116	Vss	139	Vss	162	DQ47
94	DQ4	117	DQ21	140	DQS17	163	NC
95	DQ5	118	A11	141	A10	164	VDDQ
96	VDDQ	119	DQS11	142	CB6	165	DQ52
97	DQS9	120	VDD	143	VDDQ	166	DQ53
98	DQ6	121	DQ22	144	CB7	167 ²	NC/A13
99	DQ7	122	A8	145	Vss	168	VDD
100	Vss	123	DQ23	146	DQ36	169	DQS15
101	NC	124	Vss	147	DQ37	170	DQ54
102	NC	125	A6	148	VDD	171	DQ55
103	NC	126	DQ28	149	DQS13	172	VDDQ
104	VDDQ	127	DQ29	150	DQ38	173	NC
105	DQ12	128	VDDQ	151	DQ39	174	DQ60
106	DQ13	129	DQS12	152	Vss	175	DQ61
107	DQS10	130	A3	153	DQ44	176	Vss
108	VDD	131	DQ30	154	RAS#	177	DQS16
109	DQ14	132	Vss	155	DQ45	178	DQ62
110	DQ15	133	DQ31	156	VDDQ	179	DQ63
111	NC	134	CB4	157	S0#	180	VDDQ
112	VDDQ	135	CB5	158	NC	181	SA0
113	NC	136	VDDQ	159	DQS14	182	SA1
114	DQ20	137	CK0	160	Vss	183	SA2
115 ¹	NC/A12	138	CK0#	161	DQ46	184	VDDSPD

NOTE:

1. Pin 115 is a No Connect (256MB), or A12 (512MB, 1GB, and 2GB).
2. Pin 167 is NC (256MB, 512MB, and 1GB) or A13 (2GB).

Figure 2: Pin Locations

Standard 1.70in. (43.18mm)
Front View

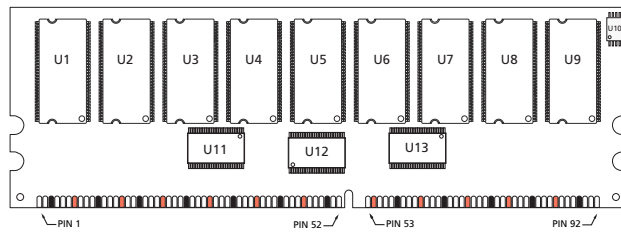

Back View

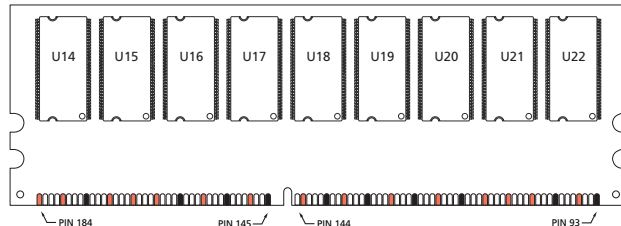

Low Profile 1.20in (30.48mm)
Front View

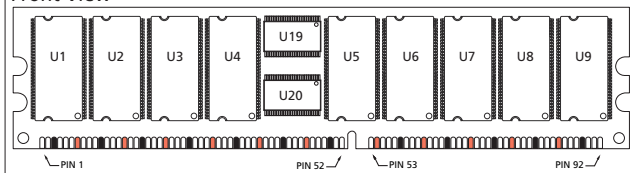

Back View

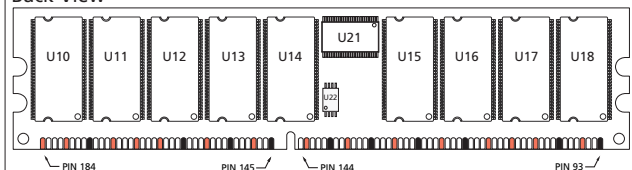

■ Indicates a VDD or VDDQ pin ■ Indicates a Vss pin

Table 5: Pin Descriptions

Pin numbers may not correlate with symbols; refer to Pin Assignment Tables on page 3 for more information

PIN NUMBERS	SYMBOL	TYPE	DESCRIPTION
10	Reset#	Input	Asynchronously forces all registered outputs LOW when RESET# is LOW. This signal can be used during power up to ensure that CKE is LOW and DQs are High-Z.
63, 65, 154	WE#, CAS#, RAS#	Input	Command Inputs: RAS#, CAS#, and WE# (along with S#) define the command being entered.
137, 138	CK0, CK0#	Input	Clock: CK, CK# are differential clock inputs. All address and control input signals are sampled on the crossing of the positive edge of CK, and negative edge of CK#. Output data (DQ and DQS) is referenced to the crossings of CK and CK#.
21	CKE0	Input	Clock Enable: CKE HIGH activates and CKE LOW deactivates the internal clock, input buffers and output drivers. Taking CKE LOW provides PRECHARGE POWER-DOWN and SELF REFRESH operations (all device banks idle), or ACTIVE POWER-DOWN (row ACTIVE in any device bank). CKE is synchronous for POWER-DOWN entry and exit, and for SELF REFRESH entry. CKE is asynchronous for SELF REFRESH exit and for disabling the outputs. CKE must be maintained HIGH throughout read and write accesses. Input buffers (excluding CK, CK# and CKE) are disabled during POWER-DOWN. Input buffers (excluding CKE) are disabled during SELF REFRESH. CKE is an SSTL_2 input but will detect an LVCMOS LOW level after VDD is applied and until CKE is first brought HIGH. After CKE is brought HIGH, it becomes an SSTL_2 input only.
157	S0#	Input	Chip Selects: S# enables (registered LOW) and disables (registered HIGH) the command decoder. All commands are masked when S# is registered HIGH. S# is considered part of the command code.
52, 59	BA0, BA1	Input	Bank Address: BA0 and BA1 define to which device bank an ACTIVE, READ, WRITE, or PRECHARGE command is being applied.
27, 29, 32, 37, 41, 43, 48, 115 (512MB, 1GB, 2GB), 118, 122, 125, 130, 141, 167 (2GB)	A0–A11 (256MB) A0–A12 (512MB, 1GB) A0–A13 (2GB)	Input	Address Inputs: Provide the row address for ACTIVE commands, and the column address and auto precharge bit (A10) for READ/WRITE commands, to select one location out of the memory array in the respective device bank. A10 sampled during a PRECHARGE command determines whether the PRECHARGE applies to one device bank (A10 LOW, device bank selected by BA0, BA1) or all device banks (A10 HIGH). The address inputs also provide the op-code during a MODE REGISTER SET command. BA0 and BA1 define which mode register (mode register or extended mode register) is loaded during the LOAD MODE REGISTER command.
5, 14, 25, 36, 47, 56, 67, 78, 86, 97, 107, 119, 129, 140, 149, 159, 169, 177	DQS0–DQS17	Input/Output	Data Strobe: Output with READ data, input with WRITE data. DQS is edge-aligned with READ data, centered in WRITE data. Used to capture data.
44, 45, 49, 51, 134, 135, 142, 144	CB0–CB7	Input/Output	Check Bits.

Table 5: Pin Descriptions (Continued)

Pin numbers may not correlate with symbols; refer to Pin Assignment Tables on page 3 for more information

PIN NUMBERS	SYMBOL	TYPE	DESCRIPTION
2, 4, 6, 8, 12, 13, 19, 20, 23, 24, 28, 31, 33, 35, 39, 40, 53, 55, 57, 60, 61, 64, 68, 69, 72, 73, 79, 80, 83, 84, 87, 88, 94, 95, 98, 99, 105, 106, 109, 110, 114, 117, 121, 123, 126, 127, 131, 133, 146, 147, 150, 151, 153, 155, 161, 162, 165, 166, 170, 171, 174, 175, 178, 179	DQ0–DQ63	Input/Output	Data I/Os: Data bus.
92	SCL	Input	Serial Clock for Presence-Detect: SCL is used to synchronize the presence-detect data transfer to and from the module.
181, 182, 183	SA0–SA2	Input	Presence-Detect Address Inputs: These pins are used to configure the presence-detect device.
91	SDA	Input/Output	Serial Presence-Detect Data: SDA is a bidirectional pin used to transfer addresses and data into and out of the presence-detect portion of the module.
1	VREF	Supply	SSTL_2 reference voltage.
15, 22, 30, 54, 62, 77, 96, 104, 112, 128, 136, 143, 156, 164, 172, 180	VDDQ	Supply	DQ Power Supply: +2.5V ±0.2V.
7, 38, 46, 70, 85, 108, 120, 148, 168	VDD	Supply	Power Supply: +2.5V ±0.2V.
3, 11, 18, 26, 34, 42, 50, 58, 66, 74, 81, 89, 93, 100, 116, 124, 132, 139, 145, 152, 160, 176	VSS	Supply	Ground.
184	VDDSPD	Supply	Serial EEPROM positive power supply: +2.3V to +3.6V.
9, 16, 17, 71, 75, 76, 82, 90, 101, 102, 103, 111, 113, 115 (256MB), 158, 163, 167 (256MB, 512MB, 1GB), 173	NC	—	No Connect: These pins should be left unconnected.

Figure 3: Standard PCB Functional Block Diagram

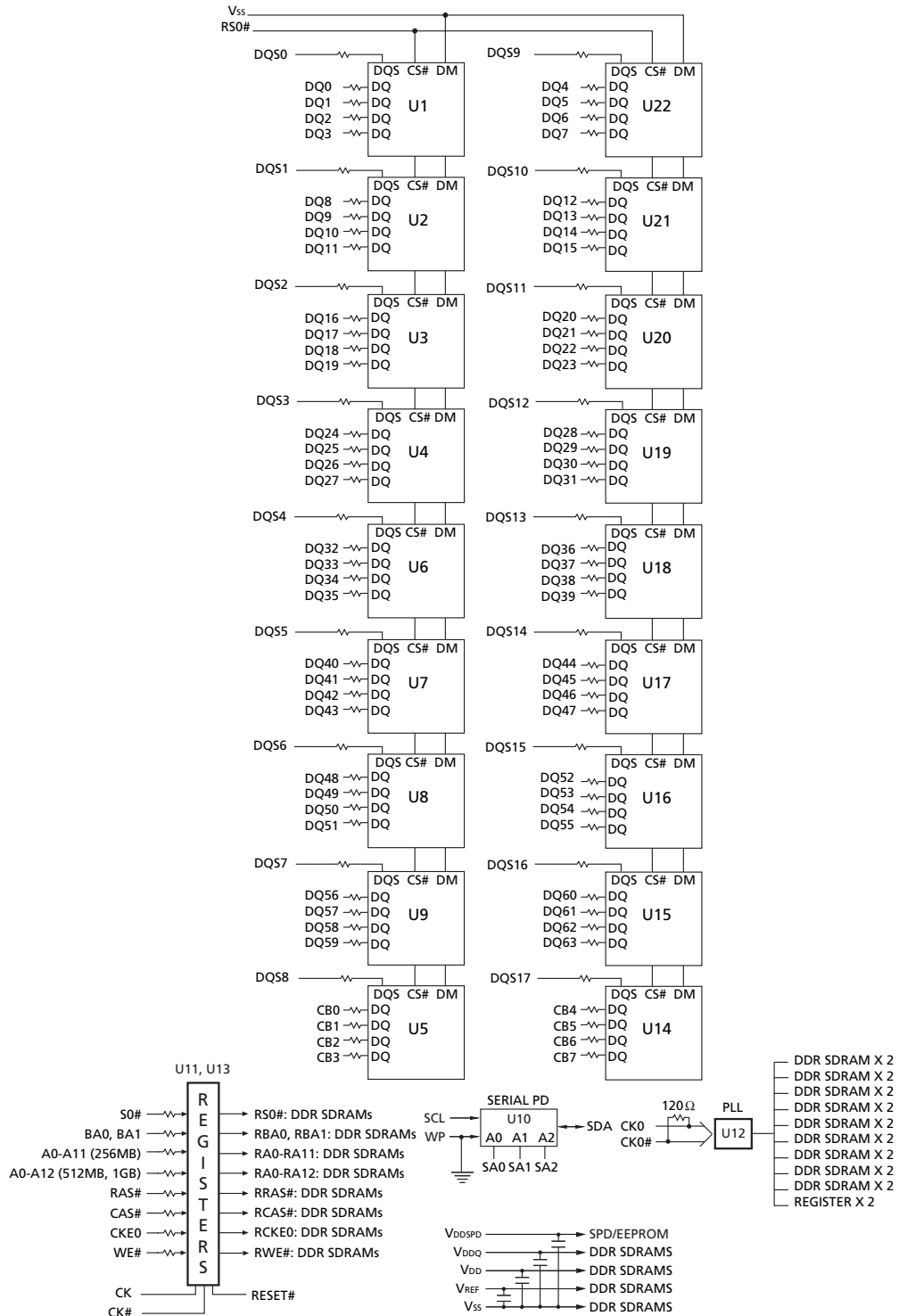

NOTE:

1. All resistor values are 22Ω unless otherwise specified.
2. Per industry standard, Micron utilizes various component speed grades as referenced in the Module Part Numbering Guide at www.micron.com/numberguide.

Standard modules use the following DDR SDRAM devices:

MT46V32M4TG (256MB); MT46V64M4TG (512MB); MT46V128M4TG (1GB); MT46V256M4TG (2GB)

Lead-free modules use the following DDR SDRAM devices:

MT46V32M4P (256MB); MT46V64M4P (512MB); MT46V128M4P (1GB); MT46V256M4TG (2GB)

Figure 4: Low Profile PCB Functional Block Diagram

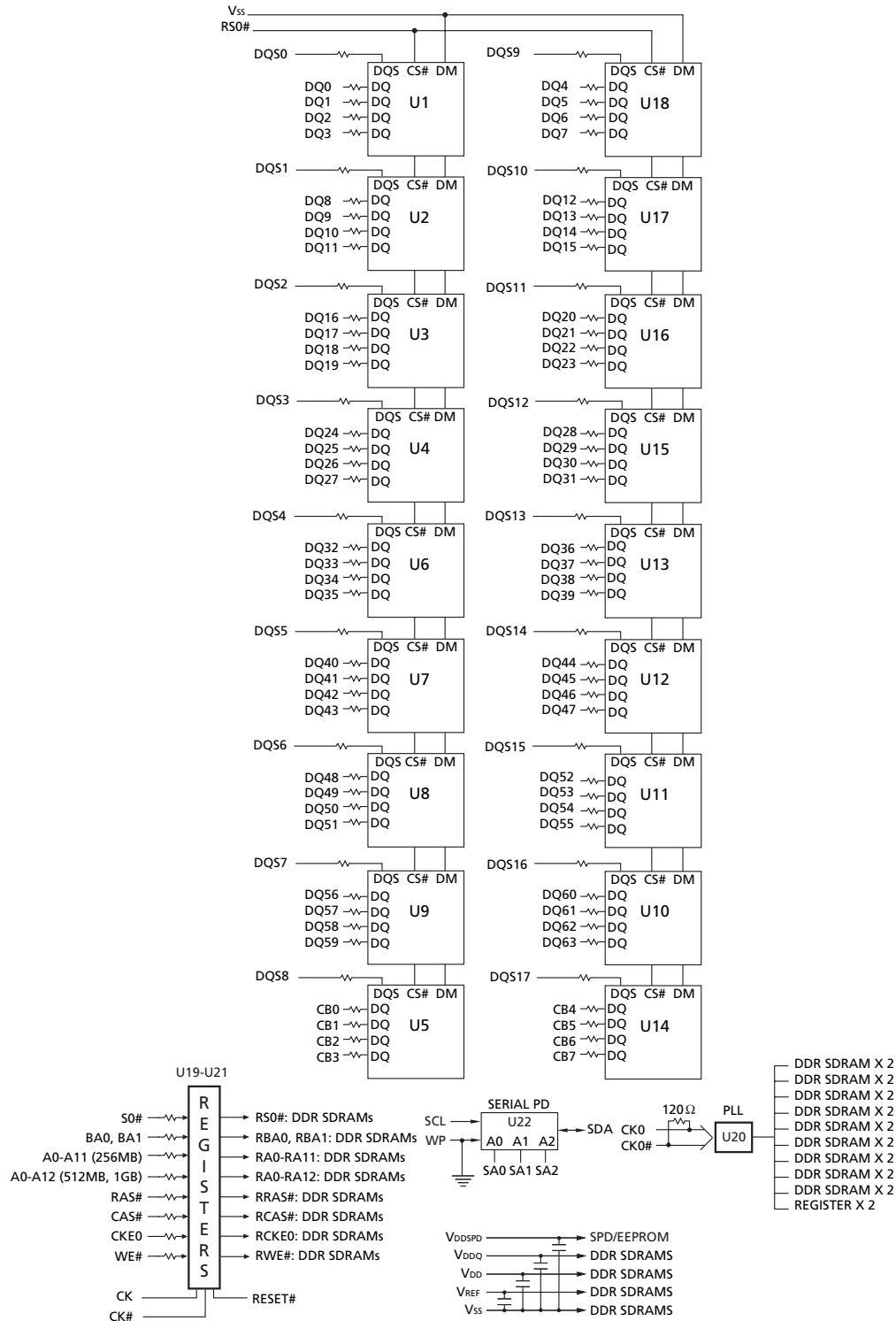

NOTE:

1. All resistor values are 22Ω unless otherwise specified.
2. Per industry standard, Micron utilizes various component speed grades as referenced in the Module Part Numbering Guide at www.micron.com/numberinguide.

Standard modules use the following DDR SDRAM devices:

MT46V32M4TG (256MB); MT46V64M4TG (512MB); MT46V128M4TG (1GB); MT46V256M4TG (2GB)

Lead-free modules use the following DDR SDRAM devices:

MT46V32M4P (256MB); MT46V64M4P (512MB); MT46V128M4P (1GB); MT46V256M4TG (2GB)

General Description

The MT18VDDT3272, MT18VDDT6472, MT18VDDT12872, and MT18VDDT25672 are high-speed CMOS, dynamic random-access, 256MB, 512MB, 1GB, and 2GB memory modules organized in x72 (ECC) configuration. DDR SDRAM modules use internally configured quad-bank DDR SDRAM devices.

DDR SDRAM modules use a double data rate architecture to achieve high-speed operation. The double data rate architecture is essentially a $2n$ -prefetch architecture with an interface designed to transfer two data words per clock cycle at the I/O pins. A single read or write access for the DDR SDRAM module effectively consists of a single $2n$ -bit wide, one-clock-cycle data transfer at the internal SDRAM core and two corresponding n -bit wide, one-half-clock-cycle data transfers at the I/O pins.

A bidirectional data strobe (DQS) is transmitted externally, along with data, for use in data capture at the receiver. DQS is an intermittent strobe transmitted by the DDR SDRAM during READs and by the memory controller during WRITEs. DQS is edge-aligned with data for READs and center-aligned with data for WRITEs.

DDR SDRAM modules operate from differential clock inputs (CK and CK#); the crossing of CK going HIGH and CK# going LOW will be referred to as the positive edge of CK. Commands (address and control signals) are registered at every positive edge of CK. Input data is registered on both edges of DQS, and output data is referenced to both edges of DQS, as well as to both edges of CK.

Read and write accesses to DDR SDRAM modules are burst oriented; accesses start at a selected location and continue for a programmed number of locations in a programmed sequence. Accesses begin with the registration of an ACTIVE command, which is then followed by a READ or WRITE command. The address bits registered coincident with the ACTIVE command are used to select the device bank and row to be accessed (BA0, BA1 select device bank; A0–A11 (256MB) or A0–A12 (512MB, 1GB), or A0–A13 (2GB) select device row). The address bits registered coincident with the READ or WRITE command are used to select the device bank and starting device column location for the burst access.

DDR SDRAM modules provide for programmable READ or WRITE burst lengths of 2, 4, or 8 locations. An auto precharge function may be enabled to provide a self-timed row precharge that is initiated at the end of the burst access.

The pipelined, multibank architecture of DDR SDRAM modules allows for concurrent operation, thereby providing effective high bandwidth by hiding row precharge and activation time.

An auto refresh mode is provided, along with a power-saving power-down mode. All inputs are compatible with the JEDEC Standard for SSTL_2. All outputs are SSTL_2, Class II compatible. For more information regarding DDR SDRAM operation, refer to the 128Mb, 256Mb, 512MB, or 1Gb DDR SDRAM component data sheets.

PLL and Register Operation

DDR SDRAM modules operate in registered mode, where the command/address input signals are latched in the registers on the rising clock edge and sent to the DDR SDRAM devices on the following rising clock edge (data access is delayed by one clock cycle). A phase-lock loop (PLL), on the module, receives and redrives the differential clock signals (CK, CK#) to the DDR SDRAM devices. The registers and PLL minimize system and clock loading.

Serial Presence-Detect Operation

DDR SDRAM modules incorporate serial presence-detect (SPD). The SPD function is implemented using a 2,048-bit EEPROM. This nonvolatile storage device contains 256 bytes. The first 128 bytes can be programmed by Micron to identify the module type and various SDRAM organizations and timing parameters. The remaining 128 bytes of storage are available for use by the customer. System READ/WRITE operations between the master (system logic) and the slave EEPROM device (DIMM) occur via a standard I²C bus using the DIMM's SCL (clock) and SDA (data) signals, together with SA (2:0), which provide eight unique DIMM/EEPROM addresses. Write protect (WP) is tied to ground on the module, permanently disabling hardware write protect.

Mode Register Definition

The mode register is used to define the specific mode of operation of DDR SDRAM devices. This definition includes the selection of a burst length, a burst type, a CAS latency and an operating mode, as shown in Figure 5, Mode Register Definition Diagram, on page 9. The mode register is programmed via the MODE REGISTER SET command (with BA0 = 0 and BA1 = 0) and will retain the stored information until it is programmed again or the device loses power (except for bit A8, which is self-clearing).

Reprogramming the mode register will not alter the contents of the memory, provided it is performed correctly. The mode register must be loaded (reloaded) when all device banks are idle and no bursts are in progress, and the controller must wait the specified time before initiating the subsequent operation. Violating either of these requirements will result in unspecified operation.

Mode register bits A0–A2 specify the burst length, A3 specifies the type of burst (sequential or interleaved), A4–A6 specify the CAS latency, and A7–A11 (256MB); A7–A12 (512MB and 1GB); or A7–A13 (2GB) specify the operating mode.

Burst Length

Read and write accesses to the DDR SDRAM devices are burst oriented, with the burst length being programmable, as shown in Figure 5, Mode Register Definition Diagram. The burst length determines the maximum number of column locations that can be accessed for a given READ or WRITE command. Burst lengths of 2, 4, or 8 locations are available for both the sequential and the interleaved burst types.

Reserved states should not be used, because unknown operation or incompatibility with future versions may result.

When a READ or WRITE command is issued, a block of columns equal to the burst length is effectively selected. All accesses for that burst take place within this block, meaning that the burst will wrap within the block if a boundary is reached. The block is uniquely selected by A1–Ai (excluding A10, which is assigned the auto precharge command) when the burst length is set to two, by A2–Ai when the burst length is set to four and by A3–Ai when the burst length is set to eight (where Ai is the most significant column address bit for a given module configuration. See Note 5 of Table 6, Burst Definition Table, on page 10, Burst Definition Table.) The remaining (least significant) address bit(s) is (are) used to select the starting location within the block. The programmed burst length applies to both READ and WRITE bursts.

Burst Type

Accesses within a given burst may be programmed to be either sequential or interleaved; this is referred to as the burst type and is selected via bit M3.

The ordering of accesses within a burst is determined by the burst length, the burst type and the starting column address, as shown in Table 6, Burst Definition Table, on page 10.

Figure 5: Mode Register Definition Diagram

256MB Module

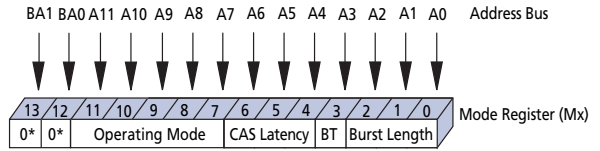

* M13 and M12 (BA0 and BA1) must be "0, 0" to select the base mode register (vs. the extended mode register).

512MB and 1GB Modules

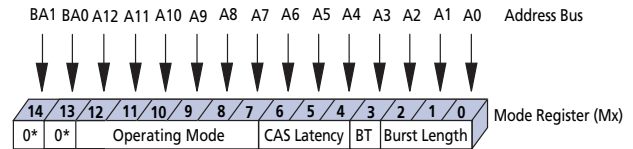

* M14 and M13 (BA0 and BA1) must be "0, 0" to select the base mode register (vs. the extended mode register).

2GB Module

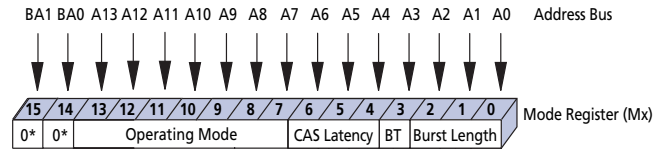

* M15 and M14 (BA1 and BA0) must be "0, 0" to select the base mode register (vs. the extended mode register).

Burst Length			
M2	M1	M0	M3 = 0
0	0	0	Reserved
0	0	1	2
0	1	0	4
0	1	1	8
1	0	0	Reserved
1	0	1	Reserved
1	1	0	Reserved
1	1	1	Reserved

M3	Burst Type
0	Sequential
1	Interleaved

M6	M5	M4	CAS Latency
0	0	0	Reserved
0	0	1	Reserved
0	1	0	2
0	1	1	Reserved
1	0	0	Reserved
1	0	1	Reserved
1	1	0	2.5
1	1	1	Reserved

M13	M12	M11	M10	M9	M8	M7	M6-M0	Operating Mode
0	0	0	0	0	0	0	Valid	Normal Operation
0	0	0	0	0	1	0	Valid	Normal Operation/Reset DLL
-	-	-	-	-	-	-	-	All other states reserved

Table 6: Burst Definition Table

BURST LENGTH	STARTING COLUMN ADDRESS		ORDER OF ACCESSES WITHIN A BURST		
			TYPE = SEQUENTIAL	TYPE = INTERLEAVED	
2	A0				
	0		0-1	0-1	
	1		1-0	1-0	
4	A1 A0				
	0	0	0-1-2-3	0-1-2-3	
	0	1	1-2-3-0	1-0-3-2	
	1	0	2-3-0-1	2-3-0-1	
	1	1	3-0-1-2	3-2-1-0	
8	A2 A1 A0				
	0	0	0	0-1-2-3-4-5-6-7	0-1-2-3-4-5-6-7
	0	0	1	1-2-3-4-5-6-7-0	1-0-3-2-5-4-7-6
	0	1	0	2-3-4-5-6-7-0-1	2-3-0-1-6-7-4-5
	0	1	1	3-4-5-6-7-0-1-2	3-2-1-0-7-6-5-4
	1	0	0	4-5-6-7-0-1-2-3	4-5-6-7-0-1-2-3
	1	0	1	5-6-7-0-1-2-3-4	5-4-7-6-1-0-3-2
	1	1	0	6-7-0-1-2-3-4-5	6-7-4-5-2-3-0-1
	1	1	1	7-0-1-2-3-4-5-6	7-6-5-4-3-2-1-0

NOTE:

- For a burst length of two, A1–Ai select the two-data-element block; A0 selects the first access within the block.
- For a burst length of four, A2–Ai select the four-data-element block; A0–A1 select the first access within the block.
- For a burst length of eight, A3–Ai select the eight-data-element block; A0–A2 select the first access within the block.
- Whenever a boundary of the block is reached within a given sequence above, the following access wraps within the block.
- $i = 9, 11$ (256MB and 512MB);
 $i = 9, 11, 12$ (1GB and 2GB).

Table 7: CAS Latency (CL) Table

SPEED	ALLOWABLE OPERATING CLOCK FREQUENCY (MHz)	
	CL = 2	CL = 2.5
-262	$75 \leq f \leq 133$	$75 \leq f \leq 133$
-26A	$75 \leq f \leq 133$	$75 \leq f \leq 133$
-265	$75 \leq f \leq 100$	$75 \leq f \leq 133$
-202	$75 \leq f \leq 100$	NA

Figure 6: CAS Latency Diagram

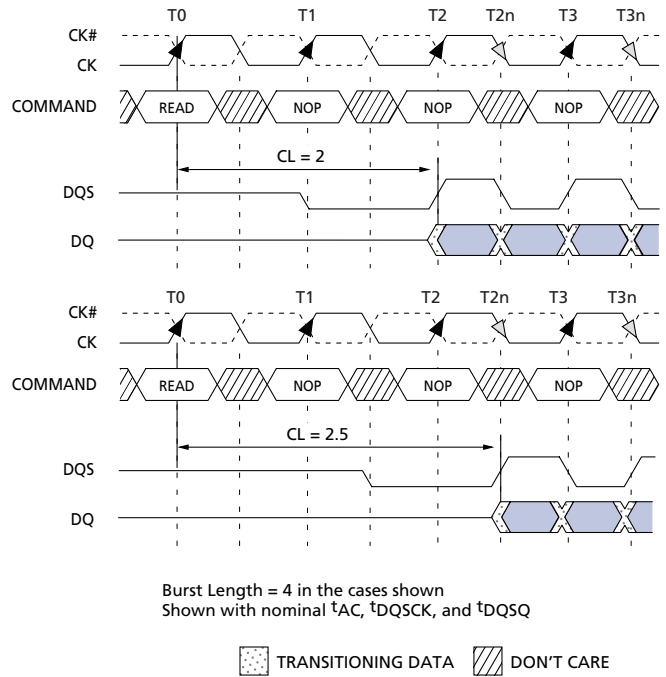

Read Latency

The READ latency is the delay, in clock cycles, between the registration of a READ command and the availability of the first bit of output data. The latency can be set to 2 or 2.5 clocks, as shown in Figure 6, CAS Latency Diagram.

If a READ command is registered at clock edge n , and the latency is m clocks, the data will be available nominally coincident with clock edge $n + m$. Table 7, CAS Latency (CL) Table, indicates the operating frequencies at which each CAS latency setting can be used.

Reserved states should not be used, because unknown operation or incompatibility with future versions may result.

Operating Mode

The normal operating mode is selected by issuing a MODE REGISTER SET command with bits A7–A11 (256MB); A7–A12 (512MB and 1GB); or A7–A13 (2GB) each set to zero, and bits A0–A6 set to the desired values. A DLL reset is initiated by issuing a MODE REGISTER SET command with bits A7 and A9–A11 (256MB); A7 and A9–A12 (512MB and 1GB); or A7–A13 (2GB) each set to zero, bit A8 set to one, and bits A0–A6 set to the desired values. Although not required by the Micron device, JEDEC specifications recommend when a LOAD MODE REGISTER command is issued to

reset the DLL, it should always be followed by a LOAD MODE REGISTER command to select normal operating mode.

All other combinations of values for A7–A11 (256MB); A7–A12 (512MB, 1GB); or A7–A13 (2GB) are reserved for future use and/or test modes. Test modes and reserved states should not be used because unknown operation or incompatibility with future versions may result.

Extended Mode Register

The extended mode register controls functions beyond those controlled by the mode register; these additional functions are DLL enable/disable and output drive strength. These functions are controlled via the bits shown in Figure 7, Extended Mode Register Definition Diagram. The extended mode register is programmed via the LOAD MODE REGISTER command to the mode register (with BA0 = 1 and BA1 = 0) and will retain the stored information until it is programmed again or the device loses power. The enabling of the DLL should always be followed by a LOAD MODE REGISTER command to the mode register (BA0/BA1 both LOW) to reset the DLL.

The extended mode register must be loaded when all device banks are idle and no bursts are in progress, and the controller must wait the specified time before initiating any subsequent operation. Violating either of these requirements could result in unspecified operation.

DLL Enable/Disable

The DLL must be enabled for normal operation. DLL enable is required during power-up initialization and upon returning to normal operation after having disabled the DLL for the purpose of debug or evaluation. (When the device exits self refresh mode, the DLL is enabled automatically.) Any time the DLL is enabled, 200 clock cycles must occur before a READ command can be issued.

Figure 7: Extended Mode Register Definition Diagram

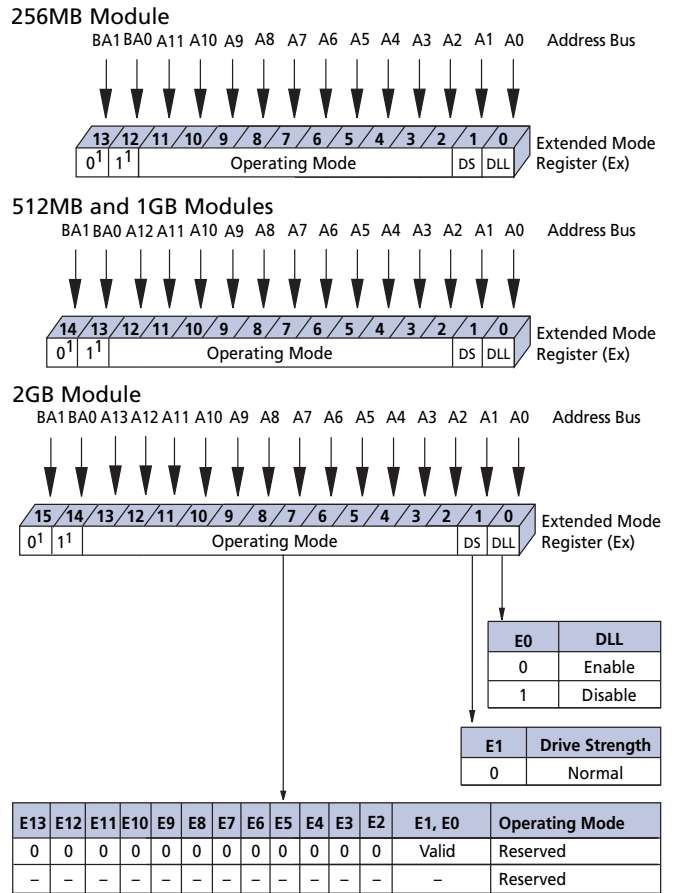

NOTE:

1. BA1 and BA0 (E13 and E12 for 256MB; E14 and E13 for 512MB, 1GB; or E15 and E14 for 2GB) must be "0, 1" to select the Extended Mode Register (vs. the base Mode Register).
2. QFC# is not supported.



Commands

Table 8, Commands Truth Table, and Table 9, DM Operation Truth Table, provide a general reference of available commands. For a more detailed description

of commands and operations, refer to the 128Mb, 256Mb, 512MB, or 1Gb DDR SDRAM component data sheet.

Table 8: Commands Truth Table

CKE is HIGH for all commands shown except SELF REFRESH; all states and sequences not shown are illegal or reserved

NAME (FUNCTION)	CS#	RAS#	CAS#	WE#	ADDR	NOTES
DESELECT (NOP)	H	X	X	X	X	1
NO OPERATION (NOP)	L	H	H	H	X	1
ACTIVE (Select bank and activate row)	L	L	H	H	Bank/Row	2
READ (Select bank and column, and start READ burst)	L	H	L	H	Bank/Col	3
WRITE (Select bank and column, and start WRITE burst)	L	H	L	L	Bank/Col	3
BURST TERMINATE	L	H	H	L	X	4
PRECHARGE (Deactivate row in bank or banks)	L	L	H	L	Code	5
AUTO REFRESH or SELF REFRESH (Enter self refresh mode)	L	L	L	H	X	6, 7
LOAD MODE REGISTER	L	L	L	L	Op-Code	8

NOTE:

1. Deselect and NOP are functionally interchangeable.
2. BA0–BA1 provide device bank address and A0–A11 (256MB), A0–A12 (512MB, 1GB), or A0–A13 (2GB) provide row address.
3. BA0–BA1 provide device bank address; A0–A9, A11(256MB, 512MB) or A0–A9, A11, A12 (1GB, 2GB) provide column address; A10 HIGH enables the auto precharge feature (nonpersistent), and A10 LOW disables the auto precharge feature.
4. Applies only to read bursts with auto precharge disabled; this command is undefined (and should not be used) for READ bursts with auto precharge enabled and for WRITE bursts.
5. A10 LOW: BA0–BA1 determine which device bank is precharged. A10 HIGH: all device banks are precharged and BA0–BA1 are "Don't Care."
6. This command is AUTO REFRESH if CKE is HIGH, SELF REFRESH if CKE is LOW.
7. Internal refresh counter controls row addressing; all inputs and I/Os are "Don't Care" except for CKE.
8. BA0–BA1 select either the mode register or the extended mode register (BA0 = 0, BA1 = 0 select the mode register; BA0 = 1, BA1 = 0 select extended mode register; other combinations of BA0–BA1 are reserved). A0–A11 (256MB), A0–A12 (512MB, 1GB), or A0–A13 (2GB) provide the op-code to be written to the selected mode register.

Table 9: DM Operation Truth Table

Used to mask write data; provided coincident with the corresponding data

NAME (FUNCTION)	DM	DQS
WRITE Enable	L	Valid
WRITE Inhibit	H	X



Absolute Maximum Ratings

Stresses greater than those listed may cause permanent damage to the device. This is a stress rating only, and functional operation of the device at these or any other conditions above those indicated in the opera-

tional sections of this specification is not implied. Exposure to absolute maximum rating conditions for extended periods may affect reliability.

Voltage on VDD Supply
Relative to VSS..... -1V to +3.6V
Voltage on VDDQ Supply
Relative to VSS..... -1V to +3.6V
Voltage on VREF and Inputs
Relative to VSS..... -1V to +3.6V

Voltage on I/O Pins
Relative to VSS -0.5V to VDDQ +0.5V
Operating Temperature
T_A (ambient) 0°C to +70°C
Storage Temperature (plastic) -55°C to +150°C
Short Circuit Output Current..... 50mA

Table 10: DC Electrical Characteristics and Operating Conditions

Notes: 1–5, 14; notes appear on pages 22–25; 0°C ≤ T_A ≤ +70°C

PARAMETER/CONDITION	SYMBOL	MIN	MAX	UNITS	NOTES
Supply Voltage	VDD	2.3	2.7	V	32, 36
I/O Supply Voltage	VDDQ	2.3	2.7	V	32, 36, 39
I/O Reference Voltage	VREF	0.49 × VDDQ	0.51 × VDDQ	V	6, 39
I/O Termination Voltage (system)	VTT	VREF - 0.04	VREF + 0.04	V	7, 39
Input High (Logic 1) Voltage	V _{IH} (DC)	VREF + 0.15	VDD + 0.3	V	25
Input Low (Logic 0) Voltage	V _{IL} (DC)	-0.3	VREF - 0.15	V	25
INPUT LEAKAGE CURRENT Any input 0V ≤ V _{IN} ≤ VDD, VREF pin 0V ≤ V _{IN} ≤ 1.35V (All other pins not under test = 0V)	Command/ Address, RAS#, CAS#, WE#, S0#, CKE	-5	5	μA	47
	CK, CK#	-10	10		
OUTPUT LEAKAGE CURRENT (DQs are disabled; 0V ≤ V _{OUT} ≤ VDDQ)	DQ, DQS	-5	5	μA	47
OUTPUT LEVELS					
High Current (V _{OUT} = VDDQ - 0.373V, minimum VREF, minimum VTT)	I _{OH}	-16.8	-	mA	33, 34
Low Current (V _{OUT} = 0.373V, maximum VREF, maximum VTT)	I _{OL}	16.8	-	mA	

Table 11: AC Input Operating Conditions

Notes: 1–5, 14; notes appear on pages 22–25; 0°C ≤ T_A ≤ +70°C; VDD = VDDQ = +2.5V ±0.2V

PARAMETER/CONDITION	SYMBOL	MIN	MAX	UNITS	NOTES
Input High (Logic 1) Voltage	V _{IH} (AC)	VREF + 0.310	-	V	12, 25, 35
Input Low (Logic 0) Voltage	V _{IL} (AC)	-	VREF - 0.310	V	12, 25, 35
I/O Reference Voltage	VREF(AC)	0.49 × VDDQ	0.51 × VDDQ	V	6



Table 12: IDD Specifications and Conditions – 256MB

DDR SDRAM components only

Notes: 1–5, 8, 10, 12; notes appear on pages 22–25; $0^{\circ}\text{C} \leq T_A \leq +70^{\circ}\text{C}$; $V_{DD} = V_{DDQ} = +2.5\text{V} \pm 0.2\text{V}$

PARAMETER/CONDITION	SYMBOL	MAX		UNITS	NOTES	
		-262	-26A/ -265/ -202			
OPERATING CURRENT: One device bank; Active-Precharge; $t_{RC} = t_{RC}$ (MIN); $t_{CK} = t_{CK}$ (MIN); DQ, DM and DQS inputs changing once per clock cycle; Address and control inputs changing once every two clock cycles	IDD0	1,017	972	mA	20, 42	
OPERATING CURRENT: One device bank; Active-Read Precharge; Burst = 2; $t_{RC} = t_{RC}$ (MIN); $t_{CK} = t_{CK}$ (MIN); $I_{OUT} = 0\text{mA}$; Address and control inputs changing once per clock cycle	IDD1	1,107	1,107	mA	20, 42	
PRECHARGE POWER-DOWN STANDBY CURRENT: All device banks idle; Power-down mode; $t_{CK} = t_{CK}$ (MIN); CKE = (LOW)	IDD2P	54	54	mA	21, 28, 44	
IDLE STANDBY CURRENT: CS# = HIGH; All device banks idle; $t_{CK} = t_{CK}$ (MIN); CKE = HIGH; Address and other control inputs changing once per clock cycle. $V_{IN} = V_{REF}$ for DQ, DQS, and DM	IDD2F	810	720	mA	45	
ACTIVE POWER-DOWN STANDBY CURRENT: One device bank active; Power-down mode; $t_{CK} = t_{CK}$ (MIN); CKE = LOW	IDD3P	450	360	mA	21, 28, 44	
ACTIVE STANDBY CURRENT: CS# = HIGH; CKE = HIGH; One device bank; Active-Precharge; $t_{RC} = t_{RAS}$ (MAX); $t_{CK} = t_{CK}$ (MIN); DQ, DM and DQS inputs changing twice per clock cycle; Address and other control inputs changing once per clock cycle	IDD3N	900	810	mA	41	
OPERATING CURRENT: Burst = 2; Reads; Continuous burst; One bank active; Address and control inputs changing once per clock cycle; $t_{CK} = t_{CK}$ (MIN); $I_{OUT} = 0\text{mA}$	IDD4R	1,197	1,152	mA	20, 42	
OPERATING CURRENT: Burst = 2; Writes; Continuous burst; One device bank active; Address and control inputs changing once per clock cycle; $t_{CK} = t_{CK}$ (MIN); DQ, DM, and DQS inputs changing twice per clock cycle	IDD4W	1,152	1,107	mA	20	
AUTO REFRESH CURRENT	$t_{REFC} = t_{RFC}$ (MIN)	IDD5	3,960	3,960	mA	24, 44
	$t_{REFC} = 15.625\mu\text{s}$	IDD5A	90	90	mA	24, 44
SELF REFRESH CURRENT: CKE $\leq 0.2\text{V}$	IDD6	54	36	mA	9	
OPERATING CURRENT: Four device bank interleaving READs (BL = 4) with auto precharge, $t_{RC} = t_{RC}$ (MIN); $t_{CK} = t_{CK}$ (MIN); Address and control inputs change only during Active READ, or WRITE commands	IDD7	2,997	2,952	mA	20, 43	

Table 13: IDD Specifications and Conditions – 512MB

DDR SDRAM components only

 Notes: 1–5, 8, 10, 12; notes appear on pages 22–25; $0^{\circ}\text{C} \leq T_A \leq +70^{\circ}\text{C}$; $V_{DD} = V_{DDQ} = +2.5\text{V} \pm 0.2\text{V}$

PARAMETER/CONDITION	SYMBOL	MAX		UNITS	NOTES	
		-262	-26A/ -265/-202			
OPERATING CURRENT: One device bank; Active-Precharge; $t_{RC} = t_{RC}$ (MIN); $t_{CK} = t_{CK}$ (MIN); DQ, DM and DQS inputs changing once per clock cycle; Address and control inputs changing once every two clock cycles	IDD0	2,250	2,160	mA	20, 42	
OPERATING CURRENT: One device bank; Active-read Precharge; Burst = 4; $t_{RC} = t_{RC}$ (MIN); $t_{CK} = t_{CK}$ (MIN); $I_{OUT} = 0\text{mA}$; Address and control inputs changing once per clock cycle	IDD1	2,880	2,610	mA	20, 42	
PRECHARGE POWER-DOWN STANDBY CURRENT: All device banks idle; Power-down mode; $t_{CK} = t_{CK}$ (MIN); CKE = (LOW)	IDD2P	72	72	mA	21, 28, 44	
IDLE STANDBY CURRENT: CS# = HIGH; All device banks idle; $t_{CK} = t_{CK}$ (MIN); CKE = HIGH; Address and other control inputs changing once per clock cycle. $V_{IN} = V_{REF}$ for DQ, DQS, and DM	IDD2F	810	810	mA	45	
ACTIVE POWER-DOWN STANDBY CURRENT: One device bank active; Power-down mode; $t_{CK} = t_{CK}$ (MIN); CKE = LOW	IDD3P	450	450	mA	21, 28, 44	
ACTIVE STANDBY CURRENT: CS# = HIGH; CKE = HIGH; One device bank; Active-Precharge; $t_{RC} = t_{RAS}$ (MAX); $t_{CK} = t_{CK}$ (MIN); DQ, DM and DQS inputs changing twice per clock cycle; Address and other control inputs changing once per clock cycle	IDD3N	900	900	mA	41	
OPERATING CURRENT: Burst = 2; Reads; Continuous burst; One bank active; Address and control inputs changing once per clock cycle; $t_{CK} = t_{CK}$ (MIN); $I_{OUT} = 0\text{mA}$	IDD4R	2,700	2,700	mA	20, 42	
OPERATING CURRENT: Burst = 2; Writes; Continuous burst; One device bank active; Address and control inputs changing once per clock cycle; $t_{CK} = t_{CK}$ (MIN); DQ, DM, and DQS inputs changing twice per clock cycle	IDD4W	2,700	2,700	mA	20	
AUTO REFRESH CURRENT	$t_{REFC} = t_{RFC}$ (MIN)	IDD5	4,230	4,230	mA	24, 44
	$t_{REFC} = 7.8125\mu\text{s}$	IDD5A	108	108	mA	24, 44
SELF REFRESH CURRENT: CKE $\leq 0.2\text{V}$	IDD6	72	72	mA	9	
OPERATING CURRENT: Four device bank interleaving READs (BL = 4) with auto precharge, $t_{RC} = t_{RC}$ (MIN); $t_{CK} = t_{CK}$ (MIN); Address and control inputs change only during Active READ, or WRITE commands	IDD7	6,300	6,300	mA	20, 43	



IDD Specifications and Conditions – 1GB

DDR SDRAM components only

Notes: 1–5, 8, 10, 12; notes appear on pages 22–25; $0^{\circ}\text{C} \leq T_A \leq +70^{\circ}\text{C}$; $V_{DD} = V_{DDQ} = +2.5\text{V} \pm 0.2\text{V}$

PARAMETER/CONDITION	SYMBOL	MAX		UNITS	NOTES	
		-262	-26A/ -265/ -202			
OPERATING CURRENT: One device bank; Active-Precharge; $t_{RC} = t_{RC}$ (MIN); $t_{CK} = t_{CK}$ (MIN); DQ, DM and DQS inputs changing once per clock cycle; Address and control inputs changing once every two clock cycles	IDD0	2,340	2,070	mA	20, 42	
OPERATING CURRENT: One device bank; Active-Read Precharge; Burst = 4; $t_{RC} = t_{RC}$ (MIN); $t_{CK} = t_{CK}$ (MIN); $I_{OUT} = 0\text{mA}$; Address and control inputs changing once per clock cycle	IDD1	2,880	2,610	mA	20, 42	
PRECHARGE POWER-DOWN STANDBY CURRENT: All device banks idle; Power-down mode; $t_{CK} = t_{CK}$ (MIN); CKE = (LOW)	IDD2P	90	90	mA	21, 28, 44	
IDLE STANDBY CURRENT: CS# = HIGH; All device banks idle; $t_{CK} = t_{CK}$ (MIN); CKE = HIGH; Address and other control inputs changing once per clock cycle. $V_{IN} = V_{REF}$ for DQ, DQS, and DM	IDD2F	810	720	mA	45	
ACTIVE POWER-DOWN STANDBY CURRENT: One device bank active; Power-down mode; $t_{CK} = t_{CK}$ (MIN); CKE = LOW	IDD3P	630	540	mA	21, 28, 44	
ACTIVE STANDBY CURRENT: CS# = HIGH; CKE = HIGH; One device bank; Active-Precharge; $t_{RC} = t_{RAS}$ (MAX); $t_{CK} = t_{CK}$ (MIN); DQ, DM and DQS inputs changing twice per clock cycle; Address and other control inputs changing once per clock cycle	IDD3N	900	810	mA	41	
OPERATING CURRENT: Burst = 2; Reads; Continuous burst; One bank active; Address and control inputs changing once per clock cycle; $t_{CK} = t_{CK}$ (MIN); $I_{OUT} = 0\text{mA}$	IDD4R	2,970	2,610	mA	20, 42	
OPERATING CURRENT: Burst = 2; Writes; Continuous burst; One device bank active; Address and control inputs changing once per clock cycle; $t_{CK} = t_{CK}$ (MIN); DQ, DM, and DQS inputs changing twice per clock cycle	IDD4W	2,790	2,430	mA	20	
AUTO REFRESH CURRENT	$t_{REFC} = t_{RFC}$ (MIN)	IDD5	5,220	5,040	mA	24, 44
	$t_{REFC} = 7.8125\mu\text{s}$	IDD5A	180	180	mA	24, 44
SELF REFRESH CURRENT: CKE $\leq 0.2\text{V}$	IDD6	90	90	mA	9	
OPERATING CURRENT: Four device bank interleaving READs (BL = 4) with auto precharge, $t_{RC} = t_{RC}$ (MIN); $t_{CK} = t_{CK}$ (MIN); Address and control inputs change only during Active READ, or WRITE commands	IDD7	7,200	6,300	mA	20, 43	



IDD Specifications and Conditions – 2GB

DDR SDRAM components only

Notes: 1–5, 8, 10, 12; notes appear on pages 22–25; $0^{\circ}\text{C} \leq T_A \leq +70^{\circ}\text{C}$; $V_{DD} = V_{DDQ} = +2.5\text{V} \pm 0.2\text{V}$

PARAMETER/CONDITION	SYMBOL	MAX		UNITS	NOTES	
		-262	-26A/ -265			
OPERATING CURRENT: One device bank; Active-Precharge; $t_{RC} = t_{RC}$ (MIN); $t_{CK} = t_{CK}$ (MIN); DQ, DM and DQS inputs changing once per clock cycle; Address and control inputs changing once every two clock cycles	IDD0	1,215	1,395	mA	20, 42	
OPERATING CURRENT: One device bank; Active-Read Precharge; Burst = 4; $t_{RC} = t_{RC}$ (MIN); $t_{CK} = t_{CK}$ (MIN); $I_{OUT} = 0\text{mA}$; Address and control inputs changing once per clock cycle	IDD1	1,485	1,710	mA	20, 42	
PRECHARGE POWER-DOWN STANDBY CURRENT: All device banks idle; Power-down mode; $t_{CK} = t_{CK}$ (MIN); CKE = (LOW)	IDD2P	90	180	mA	21, 28, 44	
IDLE STANDBY CURRENT: CS# = HIGH; All device banks idle; $t_{CK} = t_{CK}$ (MIN); CKE = HIGH; Address and other control inputs changing once per clock cycle. $V_{IN} = V_{REF}$ for DQ, DQS, and DM	IDD2F	810	1,080	mA	45	
ACTIVE POWER-DOWN STANDBY CURRENT: One device bank active; Power-down mode; $t_{CK} = t_{CK}$ (MIN); CKE = LOW	IDD3P	630	540	mA	21, 28, 44	
ACTIVE STANDBY CURRENT: CS# = HIGH; CKE = HIGH; One device bank; Active-Precharge; $t_{RC} = t_{RAS}$ (MAX); $t_{CK} = t_{CK}$ (MIN); DQ, DM and DQS inputs changing twice per clock cycle; Address and other control inputs changing once per clock cycle	IDD3N	810	810	mA	41	
OPERATING CURRENT: Burst = 2; Reads; Continuous burst; One bank active; Address and control inputs changing once per clock cycle; $t_{CK} = t_{CK}$ (MIN); $I_{OUT} = 0\text{mA}$	IDD4R	1,530	1,890	mA	20, 42	
OPERATING CURRENT: Burst = 2; Writes; Continuous burst; One device bank active; Address and control inputs changing once per clock cycle; $t_{CK} = t_{CK}$ (MIN); DQ, DM, and DQS inputs changing twice per clock cycle	IDD4W	1,440	1,980	mA	20	
AUTO REFRESH CURRENT	$t_{REFC} = t_{RFC}$ (MIN)	IDD5	5,220	5,940	mA	24, 44
	$t_{REFC} = 7.8125\mu\text{s}$	IDD5A	180	180	mA	24, 44
SELF REFRESH CURRENT: CKE $\leq 0.2\text{V}$	IDD6	90	162	mA	9	
OPERATING CURRENT: Four device bank interleaving READs (BL = 4) with auto precharge, $t_{RC} = t_{RC}$ (MIN); $t_{CK} = t_{CK}$ (MIN); Address and control inputs change only during Active READ, or WRITE commands	IDD7	3,645	4,455	mA	20, 43	



Table 14: Capacitance

Note: 11; notes appear on pages 22–25

PARAMETER	SYMBOL	MIN	MAX	UNITS
Input/Output Capacitance: DQ, DQS	C _{I0}	4	5	pF
Input Capacitance: Command and Address, S#, CKE	C _{I1}	2.5	3.5	pF
Input Capacitance:CK, CK#	C _{I2}	–	4	pF

Table 15: Electrical Characteristics and Recommended AC Operating Conditions

DDR SDRAM Components Only

Notes: 1–5, 12–15, 29; notes appear on pages 22–25; 0°C ≤ T_A ≤ +70°C; V_{DD} = V_{DDQ} = +2.5V ±0.2V

AC CHARACTERISTICS			-262			
PARAMETER		SYMBOL	MIN	MAX	UNITS	NOTES
Access window of DQs from CK/CK#		t _{AC}	-0.75	+0.75	ns	
CK high-level width		t _{CH}	0.45	0.55	t _{CK}	26
CK low-level width		t _{CL}	0.45	0.55	t _{CK}	26
Clock cycle time	CL = 2.5	t _{CK (2.5)}	7.5	13	ns	40, 46
	CL = 2	t _{CK (2)}	7.5/10	13	ns	40, 46
DQ and DM input hold time relative to DQS		t _{DH}	0.5		ns	23
DQ and DM input setup time relative to DQS		t _{DS}	0.5		ns	23
DQ and DM input pulse width (for each input)		t _{DIPW}	1.75		ns	
Access window of DQS from CK/CK#		t _{DQSCK}	-0.75	+0.75	ns	
DQS input high pulse width		t _{DQSH}	0.35		t _{CK}	
DQS input low pulse width		t _{DQSL}	0.35		t _{CK}	
DQS-DQ skew, DQS to last DQ valid, per group, per access		t _{DQSQ}		0.5	ns	22, 23
Write command to first DQS latching transition		t _{DQSS}	0.75	1.25	t _{CK}	
DQS falling edge to CK rising - setup time		t _{DSS}	0.2		t _{CK}	
DQS falling edge from CK rising - hold time		t _{DSH}	0.2		t _{CK}	
Half clock period		t _{HP}	t _{CH} , t _{CL}		ns	30
Data-out high-impedance window from CK/CK#		t _{HZ}		+0.75	ns	16, 37
Data-out low-impedance window from CK/CK#		t _{LZ}	-0.75		ns	16, 37
Address and control input hold time (fast slew rate)		t _{IHF}	0.90		ns	12
Address and control input setup time (fast slew rate)		t _{ISF}	0.90		ns	12
Address and control input hold time (slow slew rate)		t _{IHS}	1		ns	12
Address and control input setup time (slow slew rate)		t _{ISs}	1		ns	12
Address and Control input pulse width (for each input)		t _{IPW}	2.20		ns	
LOAD MODE REGISTER command cycle time		t _{MRD}	15		ns	
DQ-DQS hold, DQS to first DQ to go non-valid, per access		t _{QH}	t _{HP} - t _{QHS}		ns	22, 23
Data hold skew factor		t _{QHS}		0.75	ns	
ACTIVE to PRECHARGE command		t _{RAS}	40	120,000	ns	31
ACTIVE to READ with Auto precharge command		t _{RAP}	15		ns	
ACTIVE to ACTIVE/AUTO REFRESH command period		t _{RC}	60		ns	
AUTO REFRESH command period	256MB, 512MB, 1GB	t _{RFC}	75		ns	44
	2GB		120			
ACTIVE to READ or WRITE delay		t _{RCD}	15		ns	



**Table 15: Electrical Characteristics and Recommended AC Operating Conditions
(Continued)**

DDR SDRAM Components Only

AC CHARACTERISTICS			-262			
PARAMETER		SYMBOL	MIN	MAX	UNITS	NOTES
PRECHARGE command period		t_{RP}	15		ns	
DQS read preamble		t_{RPRE}	0.9	1.1	t_{CK}	38
DQS read postamble		t_{RPST}	0.4	0.6	t_{CK}	38
ACTIVE bank a to ACTIVE bank b command		t_{RRD}	15		ns	
DQS write preamble		t_{WPRE}	0.25		t_{CK}	
DQS write preamble setup time		t_{WPRES}	0		ns	18, 19
DQS write postamble		t_{WPST}	0.4	0.6	t_{CK}	17
Write recovery time		t_{WR}	15		ns	
Internal WRITE to READ command delay		t_{WTR}	1		t_{CK}	
Data valid output window		na	$t_{QH} - t_{DQSQ}$		ns	22
REFRESH to REFRESH command interval	256MB	t_{REFC}		140.6	μs	21
	512MB, 1GB, 2GB			70.3	μs	
Average periodic refresh interval	256MB	t_{REFI}		15.6	μs	21
	512MB, 1GB, 2GB			7.8	μs	
Terminating voltage delay to VDD		t_{VTD}	0		ns	21
Exit SELF REFRESH to non-READ command	256MB, 512MB	t_{XSNR}	75		ns	21
	1GB		127.5		ns	
Exit SELF REFRESH to READ command		t_{XSRD}	200		t_{CK}	

Table 16: DDR SDRAM Component Electrical Characteristics and Recommended AC Operating Conditions

 Notes: 1–5, 12–15, 29; notes appear on pages 22–25; $0^{\circ}\text{C} \leq T_A \leq +70^{\circ}\text{C}$; $V_{DD} = V_{DDQ} = +2.5\text{V} \pm 0.2\text{V}$

AC CHARACTERISTICS			-26A/-265		-202			
PARAMETER		SYMBOL	MIN	MAX	MIN	MAX	UNITS	NOTES
Access window of DQs from CK/CK#		t_{AC}	-0.75	+0.75	-0.8	+0.8	ns	
CK high-level width		t_{CH}	0.45	0.55	0.45	0.55	t_{CK}	26
CK low-level width		t_{CL}	0.45	0.55	0.45	0.55	t_{CK}	26
Clock cycle time	CL = 2.5	$t_{CK} (2.5)$	7.5	13	8	13	ns	40, 46
	CL = 2	$t_{CK} (2)$	7.5/10	13	10	13	ns	40, 46
DQ and DM input hold time relative to DQS		t_{DH}	0.5		0.6		ns	23
DQ and DM input setup time relative to DQS		t_{DS}	0.5		0.6		ns	23
DQ and DM input pulse width (for each input)		t_{DIPW}	1.75		2		ns	
Access window of DQS from CK/CK#		t_{DQSCK}	-0.75	+0.75	-0.8	+0.8	ns	
DQS input high pulse width		t_{DQSH}	0.35		0.35		t_{CK}	
DQS input low pulse width		t_{DQSL}	0.35		0.35		t_{CK}	
DQS-DQ skew, DQS to last DQ valid, per group, per access		t_{DQSQ}		0.5		0.6	ns	22, 23
Write command to first DQS latching transition		t_{DQSS}	0.75	1.25	0.75	1.25	t_{CK}	
DQS falling edge to CK rising - setup time		t_{DSS}	0.2		0.2		t_{CK}	
DQS falling edge from CK rising - hold time		t_{DSH}	0.2		0.2		t_{CK}	
Half clock period		t_{HP}	t_{CH}, t_{CL}		t_{CH}, t_{CL}		ns	30
Data-out high-impedance window from CK/CK#		t_{HZ}		+0.75		+0.8	ns	16, 37
Data-out low-impedance window from CK/CK#		t_{LZ}	-0.75		-0.8		ns	16, 37
Address and control input hold time (fast slew rate)		t_{IH_F}	0.90		1.1		ns	12
Address and control input setup time (fast slew rate)		t_{IS_F}	0.90		1.1		ns	12
Address and control input hold time (slow slew rate)		t_{IH_S}	1		1.1		ns	12
Address and control input setup time (slow slew rate)		t_{IS_S}	1		1.1		ns	12
Address and Control input pulse width (for each input)		t_{IPW}	2.2		2.2		ns	
LOAD MODE REGISTER command cycle time		t_{MRD}	15		16		ns	
DQ-DQS hold, DQS to first DQ to go non-valid, per access		t_{QH}	$t_{HP} - t_{QHS}$		$t_{HP} - t_{QHS}$		ns	22, 23
Data hold skew factor		t_{QHS}		0.75		1	ns	
ACTIVE to PRECHARGE command		t_{RAS}	40	120,000	40	120,000	ns	31
ACTIVE to READ with Auto precharge command		t_{RAP}	20		20		ns	
ACTIVE to ACTIVE/AUTO REFRESH command period		t_{RC}	65		70		ns	
AUTO REFRESH command period	256MB, 512MB, 1GB	t_{RFC}	75		80		ns	44
ACTIVE to READ or WRITE delay		t_{RCD}	20		20		ns	
PRECHARGE command period		t_{RP}	20		20		ns	
DQS read preamble		t_{RPRE}	0.9	1.1	0.9	1.1	t_{CK}	38
DQS read postamble		t_{RPST}	0.4	0.6	0.4	0.6	t_{CK}	38
ACTIVE bank a to ACTIVE bank b command		t_{RRD}	15		15		ns	
DQS write preamble		t_{WPRE}	0.25		0.25		t_{CK}	
DQS write preamble setup time		t_{WPRES}	0		0		ns	18, 19
DQS write postamble		t_{WPST}	0.4	0.6	0.4	0.6	t_{CK}	17



Table 16: DDR SDRAM Component Electrical Characteristics and Recommended AC Operating Conditions (Continued)

Notes: 1–5, 12–15, 29; notes appear on pages 22–25; $0^{\circ}\text{C} \leq T_A \leq +70^{\circ}\text{C}$; $V_{DD} = V_{DDQ} = +2.5\text{V} \pm 0.2\text{V}$

AC CHARACTERISTICS			-26A/-265		-202			
PARAMETER		SYMBOL	MIN	MAX	MIN	MAX	UNITS	NOTES
Write recovery time		t_{WR}	15		15		ns	
Internal WRITE to READ command delay		t_{WTR}	1		1		t_{CK}	
Data valid output window		NA	$t_{QH} - t_{DQSQ}$		$t_{QH} - t_{DQSQ}$		ns	22
REFRESH to REFRESH command interval	256MB	t_{REFC}		140.6		140.6	μs	21
	512MB, 1GB, 2GB			70.3		70.3	μs	
Average periodic refresh interval	256MB	t_{REFI}		15.6		15.6	μs	21
	512MB, 1GB, 2GB			7.8		7.8	μs	
Terminating voltage delay to V_{DD}		t_{VTD}	0		0		ns	21
Exit SELF REFRESH to non-READ command	256MB, 512MB	t_{XSNR}	75		75		ns	21
	1GB		127.5		127.5		ns	
Exit SELF REFRESH to READ command		t_{XSRD}	200		200		t_{CK}	

Notes

1. All voltages referenced to VSS.
2. Tests for AC timing, I_{DD} , and electrical AC and DC characteristics may be conducted at nominal reference/supply voltage levels, but the related specifications and device operation are guaranteed for the full voltage range specified.
3. Outputs measured with equivalent load:

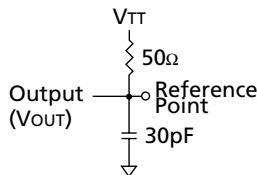

4. AC timing and I_{DD} tests may use a V_{IL} -to- V_{IH} swing of up to 1.5V in the test environment, but input timing is still referenced to V_{REF} (or to the crossing point for CK/CK#), and parameter specifications are guaranteed for the specified AC input levels under normal use conditions. The minimum slew rate for the input signals used to test the device is 1V/ns in the range between $V_{IL(AC)}$ and $V_{IH(AC)}$.
5. The AC and DC input level specifications are as defined in the SSTL_2 Standard (i.e., the receiver will effectively switch as a result of the signal crossing the AC input level, and will remain in that state as long as the signal does not ring back above [below] the DC input LOW [HIGH] level).
6. V_{REF} is expected to equal $V_{DDQ}/2$ of the transmitting device and to track variations in the DC level of the same. Peak-to-peak noise (non-common mode) on V_{REF} may not exceed ± 2 percent of the DC value. Thus, from $V_{DDQ}/2$, V_{REF} is allowed ± 25 mV for DC error and an additional ± 25 mV for AC noise. This measurement is to be taken at the nearest V_{REF} by-pass capacitor.
7. V_{TT} is not applied directly to the device. V_{TT} is a system supply for signal termination resistors, is expected to be set equal to V_{REF} and must track variations in the DC level of V_{REF} .
8. I_{DD} is dependent on output loading and cycle rates. Specified values are obtained with minimum cycle time at $CL = 2$ for -26A and -202, $CL = 2.5$ for -265 with the outputs open.
9. Enables on-chip refresh and address counters.
10. I_{DD} specifications are tested after the device is properly initialized, and is averaged at the defined cycle rate.
11. This parameter is sampled. $V_{DD} = +2.5V \pm 0.2V$, $V_{DDQ} = +2.5V \pm 0.2V$, $V_{REF} = V_{SS}$, $f = 100$ MHz,
12. $T_A = 25^\circ C$, $V_{OUT} (DC) = V_{DDQ}/2$, $V_{OUT} (peak\ to\ peak) = 0.2V$. DM input is grouped with I/O pins, reflecting the fact that they are matched in loading.
13. For slew rates $< 1V/ns$ and $\geq 0.5V/ns$. If slew rate is $< 0.5V/ns$, timing must be derated: t_{IS} has an additional 50ps per each 100 mV/ns reduction in slew rate from 500 mV/ns, while t_{IH} is unaffected. If slew rate exceeds 4.5 V/ns, functionality is uncertain.
14. The CK/CK# input reference level (for timing referenced to CK/CK#) is the point at which CK and CK# cross; the input reference level for signals other than CK/CK# is V_{REF} .
15. Inputs are not recognized as valid until V_{REF} stabilizes. Exception: during the period before V_{REF} stabilizes, $CKE \leq 0.3 \times V_{DDQ}$ is recognized as LOW.
16. The output timing reference level, as measured at the timing reference point indicated in Note 3, is V_{TT} .
17. t_{HZ} and t_{LZ} transitions occur in the same access time windows as data valid transitions. These parameters are not referenced to a specific voltage level, but specify when the device output is no longer driving (HZ) or begins driving (LZ).
18. The intent of the Don't Care state after completion of the postamble is the DQS-driven signal should either be high, low, or high-Z and that any signal transition within the input switching region must follow valid input requirements. That is, if DQS transitions high (above V_{IHDC} (MIN)) then it must not transition low (below V_{IHDC}) prior to t_{DQSH} (MIN).
19. This is not a device limit. The device will operate with a negative value, but system performance could be degraded due to bus turnaround.
20. It is recommended that DQS be valid (HIGH or LOW) on or before the WRITE command. The case shown (DQS going from High-Z to logic LOW) applies when no WRITES were previously in progress on the bus. If a previous WRITE was in progress, DQS could be HIGH during this time, depending on t_{DQSS} .
21. MIN (t_{RC} or t_{RFC}) for I_{DD} measurements is the smallest multiple of t_{CK} that meets the minimum absolute value for the respective parameter. t_{RAS} (MAX) for I_{DD} measurements is the largest multiple of t_{CK} that meets the maximum absolute value for t_{RAS} .
22. The refresh period 64ms. This equates to an average refresh rate of 15.625 μs (256MB) or 7.8125 μs (512MB, 1GB, 2GB). However, an AUTO REFRESH command must be asserted at least once every 140.6 μs (256MB) or 70.3 μs (512MB, 1GB, 2GB);

- burst refreshing or posting by the DRAM controller greater than eight refresh cycles is not allowed.
22. The valid data window is derived by achieving other specifications: t_{HP} ($t_{CK}/2$), t_{DQSQ} , and t_{QH} ($t_{QH} = t_{HP} - t_{QHS}$). The data valid window derates directly proportional with the clock duty cycle and a practical data valid window can be derived. The clock is allowed a maximum duty cycle variation of 45/55, beyond which functionality is uncertain. Figure 8, Derating Data Valid Window, shows derating curves for duty cycles ranging between 50/50 and 45/55.
 23. Each device has a corresponding DQS.
 24. This limit is actually a nominal value and does not result in a fail value. CKE is HIGH during REFRESH command period (t_{RFC} [MIN]) else CKE is LOW (i.e., during standby).
 25. To maintain a valid level, the transitioning edge of the input must:
 - a. Sustain a constant slew rate from the current AC level through to the target AC level, V_{IL} (AC) or V_{IH} (AC).
 - b. Reach at least the target AC level.
 - c. After the AC target level is reached, continue to maintain at least the target DC level, V_{IL} (DC) or V_{IH} (DC).
 26. CK and CK# input slew rate must be $\geq 1V/ns$ (2V/ns differentially).
 27. DQ and DM input slew rates must not deviate from DQS by more than 10 percent. If the DQ/DM/DQS slew rate is less than 0.5V/ns, timing must be derated: 50ps must be added to t_{DS} and t_{DH} for each 100mv/ns reduction in slew rate. If slew rate exceeds 4V/ns, functionality is uncertain.
 28. VDD must not vary more than 4 percent if CKE is not active while any bank is active.
 29. The clock is allowed up to $\pm 150ps$ of jitter. Each timing parameter is allowed to vary by the same amount.
 30. t_{HP} min is the lesser of t_{CL} minimum and t_{CH} minimum actually applied to the device CK and CK# inputs, collectively during bank active.

Figure 8: Derating Data Valid Window

($t_{QH} - t_{DQSQ}$)

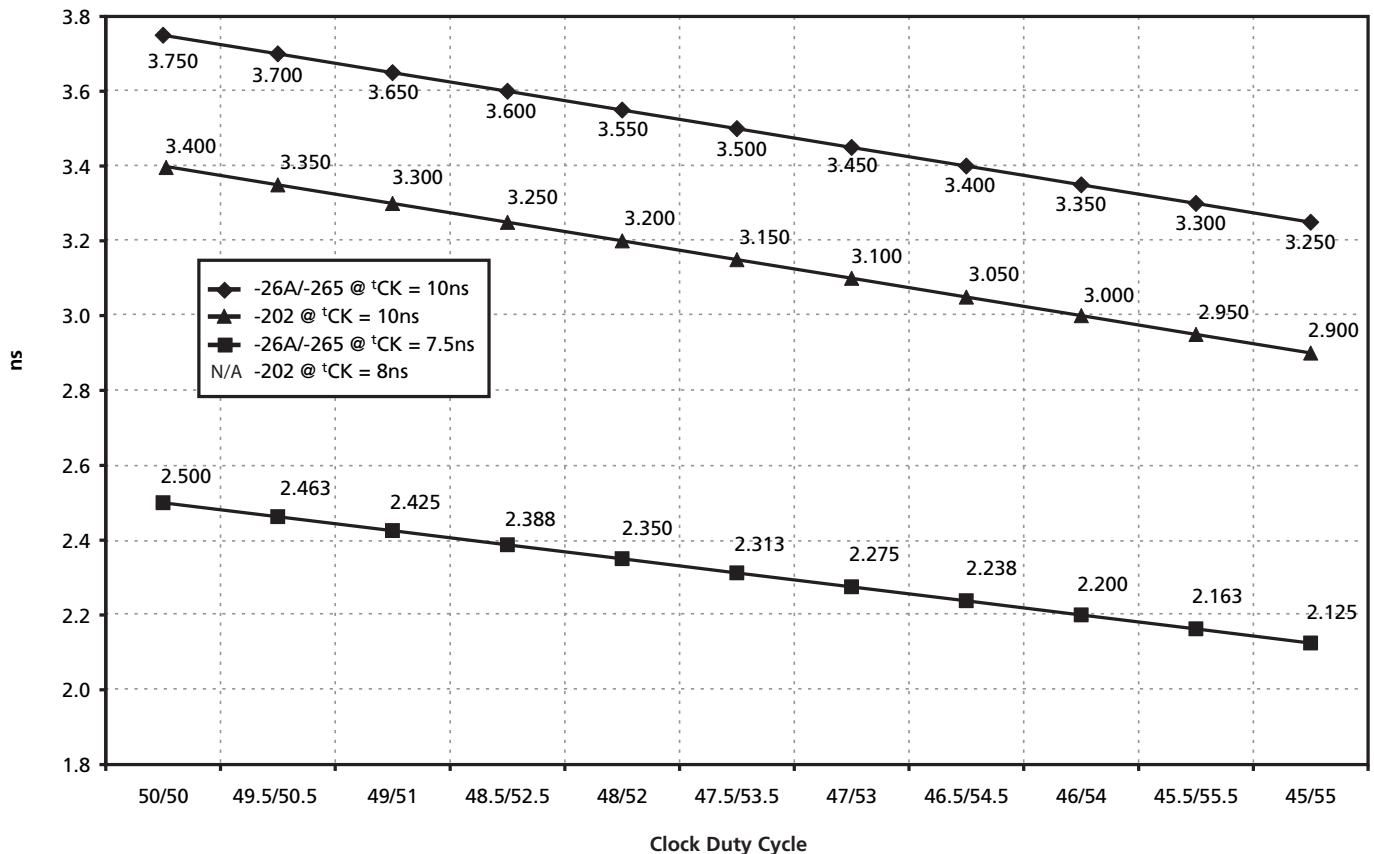

31. READs and WRITEs with auto precharge are not allowed to be issued until $t_{\text{RAS}}(\text{MIN})$ can be satisfied prior to the internal precharge command being issued.
32. Any positive glitch in the nominal voltage must be less than 1/3 of the clock and not more than +400mV or 2.9V, whichever is less. Any negative glitch must be less than 1/3 of the clock cycle and not exceed either -300mV or 2.2V, whichever is more positive.
33. Normal Output Drive Curves:
 - a. The full variation in driver pull-down current from minimum to maximum process, temperature and voltage will lie within the outer bounding lines of the V-I curve of Figure 9, Pull-Down Characteristics.
 - b. The variation in driver pull-down current within nominal limits of voltage and temperature is expected, but not guaranteed, to lie within the inner bounding lines of the V-I curve of Figure 9, Pull-Down Characteristics.
 - c. The full variation in driver pull-up current from minimum to maximum process, temperature and voltage will lie within the outer bounding lines of the V-I curve of Figure 10, Pull-Up Characteristics.
 - d. The variation in driver pull-up current within nominal limits of voltage and temperature is expected, but not guaranteed, to lie within the inner bounding lines of the V-I curve of Figure 10, Pull-Up Characteristics.
 - e. The full variation in the ratio of the maximum to minimum pull-up and pull-down current should be between 0.71 and 1.4, for device drain-to-source voltages from 0.1V to 1.0V, and at the same voltage and temperature.
 - f. The full variation in the ratio of the nominal pull-up to pull-down current should be unity ± 10 percent, for device drain-to-source voltages from 0.1V to 1.0V.
34. The voltage levels used are derived from a minimum VDD level and the referenced test load. In practice, the voltage levels obtained from a properly terminated bus will provide significantly different voltage values.
35. V_{IH} overshoot: $V_{\text{IH}}(\text{MAX}) = V_{\text{DDQ}} + 1.5\text{V}$ for a pulse width $\leq 3\text{ns}$ and the pulse width can not be greater than 1/3 of the cycle rate. V_{IL} undershoot: $V_{\text{IL}}(\text{MIN}) = -1.5\text{V}$ for a pulse width $\leq 3\text{ns}$ and the pulse width can not be greater than 1/3 of the cycle rate.
36. VDD and VDDQ must track each other.
37. $t_{\text{HZ}}(\text{MAX})$ will prevail over $t_{\text{DQCK}}(\text{MAX}) + t_{\text{RPST}}(\text{MAX})$ condition. $t_{\text{LZ}}(\text{MIN})$ will prevail over $t_{\text{DQCK}}(\text{MIN}) + t_{\text{RPRE}}(\text{MAX})$ condition.
38. t_{RPST} end point and t_{RPRE} begin point are not referenced to a specific voltage level but specify when the device output is no longer driving (t_{RPST}), or begins driving (t_{RPRE}).
39. During initialization, VDDQ, VTT, and VREF must be equal to or less than VDD + 0.3V. Alternatively, VTT may be 1.35V maximum during power up, even if VDD/VDDQ are 0V, provided a minimum of 42Ω of series resistance is used between the VTT supply and the input pin.
40. The current Micron part operates below the slowest JEDEC operating frequency of 83 MHz. As such, future die may not reflect this option.
41. For -262, -26A, and -265, IDD3N is specified to be 35mA per DDR SDRAM device at 100 MHz.
42. Random address changing and 50 percent of data changing at every transfer.

Figure 9: Pull-Down Characteristics

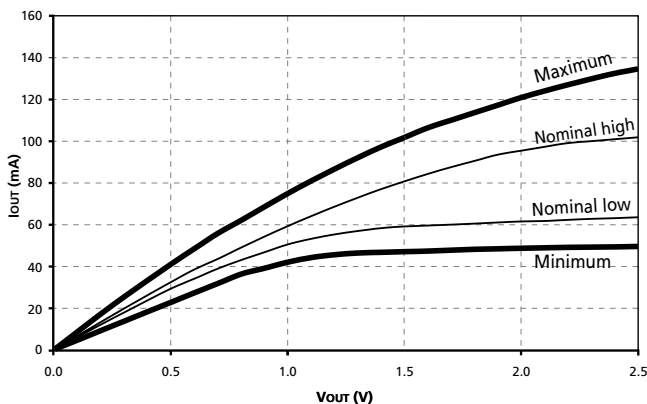
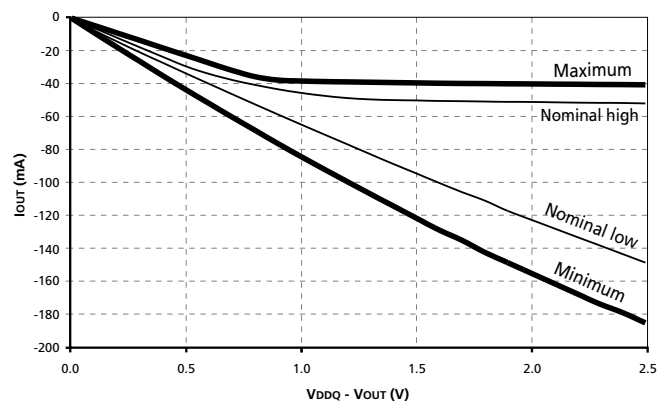

Figure 10: Pull-Up Characteristics



43. Random address changing and 100 percent of data changing at every transfer.
44. CKE must be active (high) during the entire time a refresh command is executed. That is, from the time the AUTO REFRESH command is registered, CKE must be active at each rising clock edge, until t_{REF} later.
45. IDD2N specifies the DQ, DQS, and DM to be driven to a valid high or low logic level. IDD2Q is similar to IDD2F except IDD2Q specifies the address and control inputs to remain stable. Although IDD2F, IDD2N, and IDD2Q are similar, IDD2F is “worst case.”
46. Whenever the operating frequency is altered, not including jitter, the DLL is required to be reset. This is followed by 200 clock cycles (before READ commands).
47. Leakage number reflects the worst case leakage possible through the module pin, not what each memory device contributes.
48. When an input signal is indicated to be HIGH or LOW, it is defined as a steady state logic HIGH or LOW.
49. The -335 speed grade will operate with $t_{RAS} (MIN) = 40ns$ and $t_{RAS} (MAX) = 120,000ns$ at any slower frequency.

Initialization

To ensure device operation the DRAM must be initialized as described below:

1. Simultaneously apply power to VDD and VDDQ.
2. Apply VREF and then VTT power.
3. Assert and hold CKE at a LVCMOS logic low.
4. Provide stable CLOCK signals.
5. Wait at least 200 μ s.
6. Bring CKE high and provide at least one NOP or DESELECT command. At this point the CKE input changes from a LVCMOS input to a SSTL2 input only and will remain a SSTL_2 input unless a power cycle occurs.
7. Perform a PRECHARGE ALL command.
8. Wait at least t_{RP} time, during this time NOPs or DESELECT commands must be given.
9. Using the LMR command program the Extended Mode Register (E0 = 0 to enable the DLL and E1 = 0 for normal drive or E1 = 1 for reduced drive, E2 through En must be set to 0; where n = most significant bit).
10. Wait at least t_{MRD} time, only NOPs or DESELECT commands are allowed.
11. Using the LMR command program the Mode Register to set operating parameters and to reset the DLL. Note at least 200 clock cycles are required between a DLL reset and any READ command.
12. Wait at least t_{MRD} time, only NOPs or DESELECT commands are allowed.
13. Issue a PRECHARGE ALL command.
14. Wait at least t_{RP} time, only NOPs or DESELECT commands are allowed.
15. Issue an AUTO REFRESH command (Note this may be moved prior to step 13).
16. Wait at least t_{RFC} time, only NOPs or DESELECT commands are allowed.
17. Issue an AUTO REFRESH command (Note this may be moved prior to step 13).
18. Wait at least t_{RFC} time, only NOPs or DESELECT commands are allowed.
19. Although not required by the Micron device, JEDEC requires a LMR command to clear the DLL bit (set M8 = 0). If a LMR command is issued the same operating parameters should be utilized as in step 11.
20. Wait at least t_{MRD} time, only NOPs or DESELECT commands are allowed.
21. At this point the DRAM is ready for any valid command. Note 200 clock cycles are required between step 11 (DLL Reset) and any READ command.

Figure 11: Initialization Flow Diagram

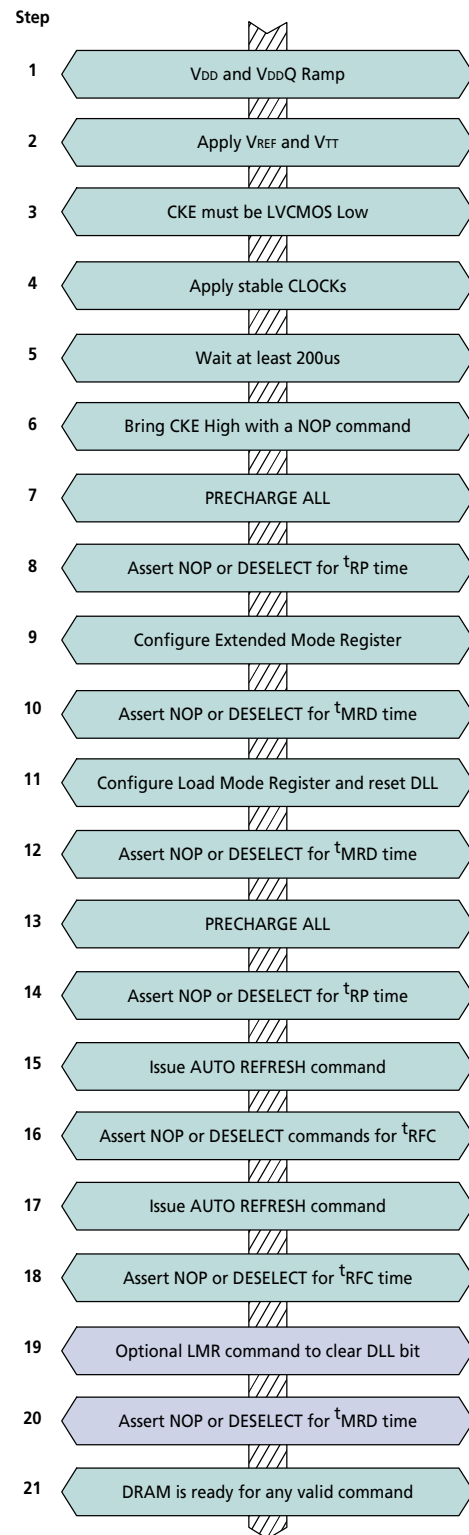

Table 17: Register Timing Requirements and Switching Characteristics

Note: 1

REGISTER	SYMBOL	PARAMETER	CONDITION	0°C ≤ T _A ≤ +70°C V _{DD} = +2.5V ±0.2V		UNITS	NOTES
				MIN	MAX		
SSTL (bit pattern) by JESD82-3 or JESD82-4	f _{clock}	Clock Frequency		-	200	MHz	
	t _{pd}	Clock to Output Time	30pF to GND and 50Ω to V _{TT}	1.1	2.8	ns	
	t _{PHL}	Reset to Output Time		-	5	ns	
	t _w	Pulse Duration	CK, CK# HIGH or LOW	2.5	-	ns	
	t _{act}	Differential Inputs Active Time		-	22	ns	2
	t _{inact}	Differential Inputs Inactive Time		-	22	ns	3
	t _{su}	Setup Time, Fast Slew Rate	Data Before CK HIGH, CK# LOW	0.75	-	ns	4, 6
		Setup Time, Slow Slew Rate		0.9	-	ns	5, 6
	t _h	Hold Time, Fast Slew Rate	Data After CK HIGH, CK# LOW	0.75	-	ns	4, 6
Hold Time, Slow Slew Rate		0.9		-	ns	5, 6	

NOTE:

1. The timing and switching specifications for the register listed above are critical for proper operation of the DDR SDRAM Registered DIMMs. These are meant to be a subset of the parameters for the specific device used on the module. Detailed information for this register is available in JEDEC Standard JESD82.
2. Data inputs must be low a minimum time of t_{act} max, after RESET# is taken HIGH.
3. Data and clock inputs must be held at valid levels (not floating) a minimum time of t_{inact} max, after RESET# is taken LOW.
4. For data signal input slew rate ≥ 1 V/ns.
5. For data signal input slew rate ≥ 0.5 V/ns and < 1V/ns.
6. CK, CK# signals input slew rate ≥ 1V/ns.

Table 18: PLL Clock Driver Timing Requirements and Switching Characteristics

Note: 1

PARAMETER	SYMBOL	0°C ≤ T _A ≤ +70°C V _{DD} = +2.5V ±0.2V			UNITS	NOTES
		MIN	NOMINAL	MAX		
Operating Clock Frequency	f _{CK}	60	-	170	MHz	2, 3
Input Duty Cycle	t _{DC}	40	-	60	%	
Stabilization Time	t _{STAB}	-	-	100	ms	4
Cycle to Cycle Jitter	t _{JIT_{CC}}	-75	-	75	ps	
Static Phase Offset	t _∅	-50	0	50	ps	5
Output Clock Skew	t _{SK_O}	-	-	100	ps	
Period Jitter	t _{JIT_{PER}}	-75	-	75	ps	6
Half-Period Jitter	t _{JIT_{HPER}}	-100	-	100	ps	6
Input Clock Slew Rate	t _{LS_I}	1.0	-	4	V/ns	
Output Clock Slew Rate	t _{LS_O}	1.0	-	2	V/ns	7

NOTE:

1. The timing and switching specifications for the PLL listed above are critical for proper operation of the DDR SDRAM Registered DIMMs. These are meant to be a subset of the parameters for the specific device used on the module. Detailed information for this PLL is available in JEDEC Standard JESD82.
2. The PLL must be able to handle spread spectrum induced skew.
3. Operating clock frequency indicates a range over which the PLL must be able to lock, but in which it is not required to meet the other timing parameters. (Used for low speed system debug.)
4. Stabilization time is the time required for the integrated PLL circuit to obtain phase lock of its feedback signal to its reference signal after power up.
5. Static Phase Offset does not include Jitter.
6. Period Jitter and Half-Period Jitter specifications are separate specifications that must be met independently of each other.
7. The Output Slew Rate is determined from the IBIS model:

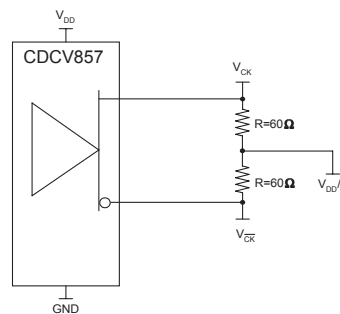
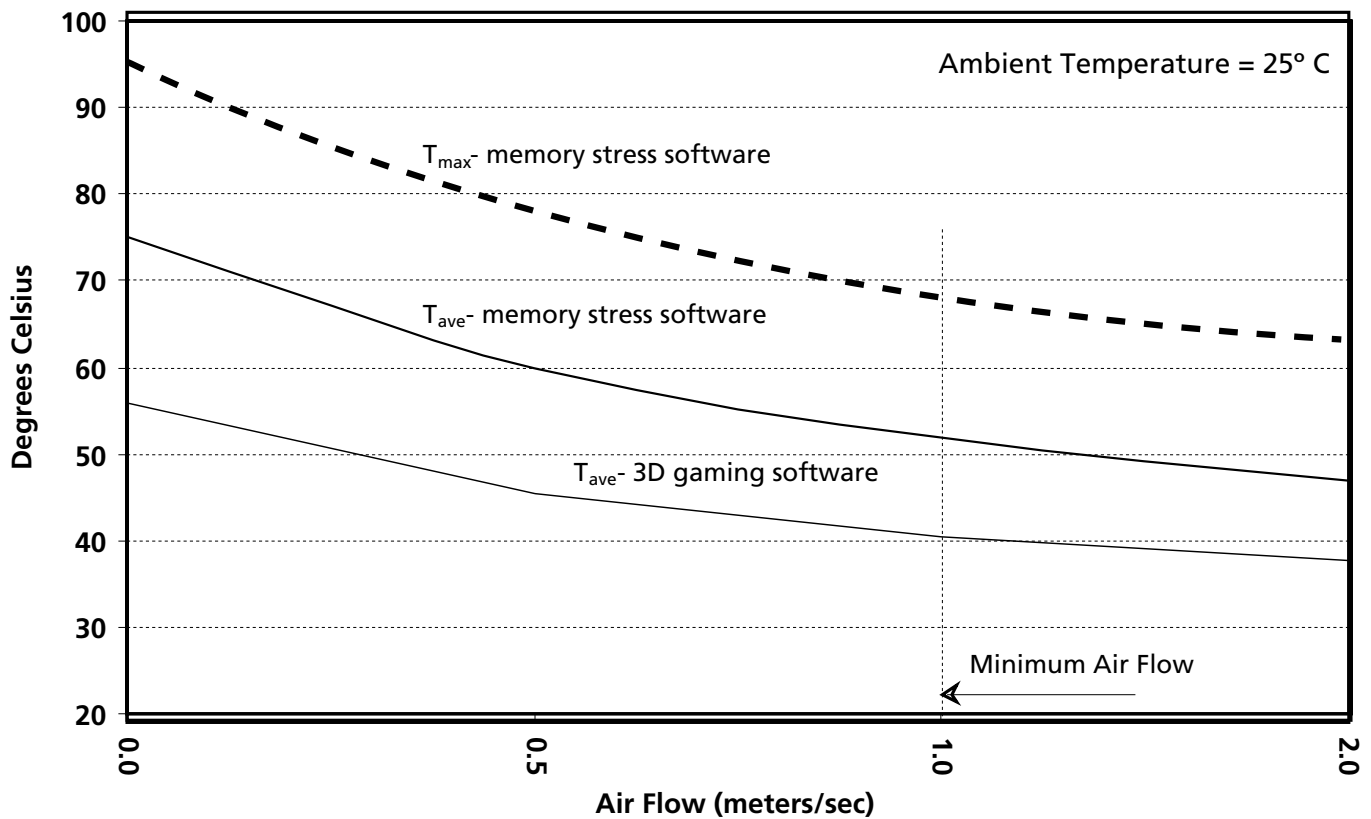

Figure 12: Component Case Temperature vs. Air Flow



NOTE:

1. Micron Technology, Inc. recommends a minimum air flow of 1 meter/second (~197 LFM) across the module.
2. The component case temperature measurements shown above were obtained experimentally. The typical system to be used for experimental purposes is a dual-processor 600 MHz work station, fully loaded, with four comparable registered memory modules. Case temperatures charted represent worst-case component locations on modules installed in the internal slots of the system.
3. Temperature versus air speed data is obtained by performing experiments with the system motherboard removed from its case and mounted in a Eiffel-type low air speed wind tunnel. Peripheral devices installed on the system motherboard for testing are the processor(s) and video card, all other peripheral devices are mounted outside of the wind tunnel test chamber.
4. The memory diagnostic software used for determining worst-case component temperatures is a memory diagnostic software application developed for internal use by Micron Technology, Inc.

SPD Clock and Data Conventions

Data states on the SDA line can change only during SCL LOW. SDA state changes during SCL HIGH are reserved for indicating start and stop conditions (as shown in Figure 13, Data Validity, and Figure 14, Definition of Start and Stop).

SPD Start Condition

All commands are preceded by the start condition, which is a HIGH-to-LOW transition of SDA when SCL is HIGH. The SPD device continuously monitors the SDA and SCL lines for the start condition and will not respond to any command until this condition has been met.

SPD Stop Condition

All communications are terminated by a stop condition, which is a LOW-to-HIGH transition of SDA when SCL is HIGH. The stop condition is also used to place the SPD device into standby power mode.

SPD Acknowledge

Acknowledge is a software convention used to indicate successful data transfers. The transmitting device, either master or slave, will release the bus after transmitting eight bits. During the ninth clock cycle, the receiver will pull the SDA line LOW to acknowledge that it received the eight bits of data (as shown in Figure 15, Acknowledge Response From Receiver).

The SPD device will always respond with an acknowledge after recognition of a start condition and its slave address. If both the device and a WRITE operation have been selected, the SPD device will respond with an acknowledge after the receipt of each subsequent eight-bit word. In the read mode the SPD device will transmit eight bits of data, release the SDA line and monitor the line for an acknowledge. If an acknowledge is detected and no stop condition is generated by the master, the slave will continue to transmit data. If an acknowledge is not detected, the slave will terminate further data transmissions and await the stop condition to return to standby power mode.

Figure 13: Data Validity

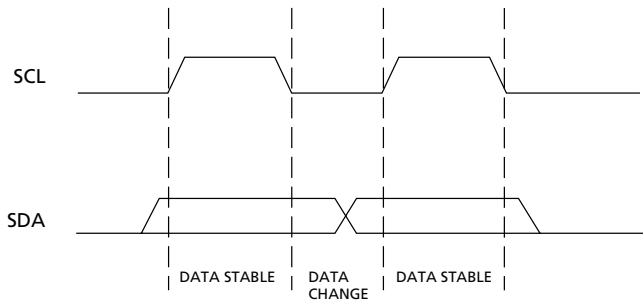

Figure 14: Definition of Start and Stop

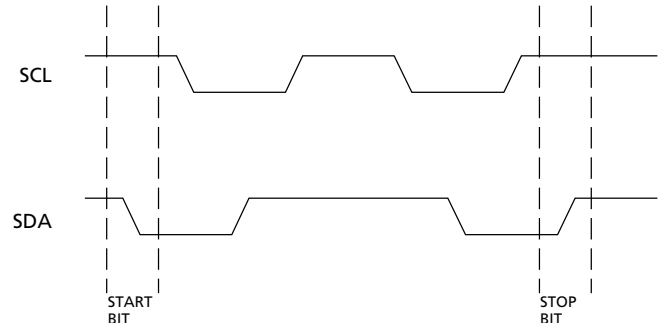

Figure 15: Acknowledge Response From Receiver

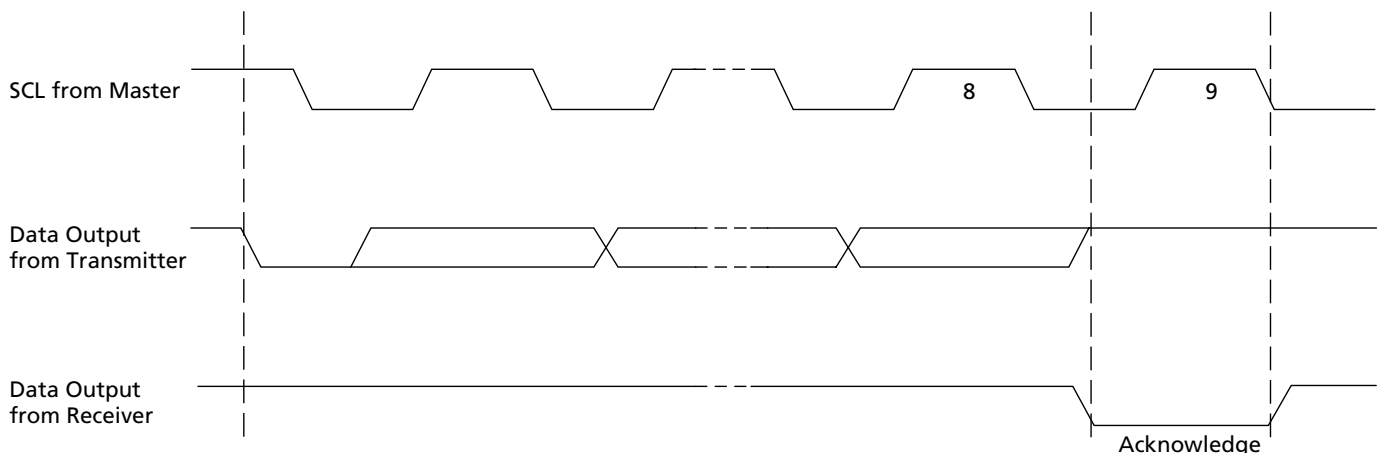

Table 19: EEPROM Device Select Code

The most significant bit (b7) is sent first

SELECT CODE	DEVICE TYPE IDENTIFIER				CHIP ENABLE			R \overline{W}
	b7	b6	b5	b4	b3	b2	b1	b0
Memory Area Select Code (two arrays)	1	0	1	0	SA2	SA1	SA0	R \overline{W}
Protection Register Select Code	0	1	1	0	SA2	SA1	SA0	R \overline{W}

Table 20: EEPROM Operating Modes

MODE	R \overline{W} BIT	W \overline{C}	BYTES	INITIAL SEQUENCE
Current Address Read	1	V _{IH} or V _{IL}	1	START, Device Select, R \overline{W} = '1'
Random Address Read	0	V _{IH} or V _{IL}	1	START, Device Select, R \overline{W} = '0', Address
	1	V _{IH} or V _{IL}	1	reSTART, Device Select, R \overline{W} = '1'
Sequential Read	1	V _{IH} or V _{IL}	≥ 1	Similar to Current or Random Address Read
Byte Write	0	V _{IL}	1	START, Device Select, R \overline{W} = '0'
Page Write	0	V _{IL}	≤ 16	START, Device Select, R \overline{W} = '0'

Figure 16: SPD EEPROM Timing Diagram

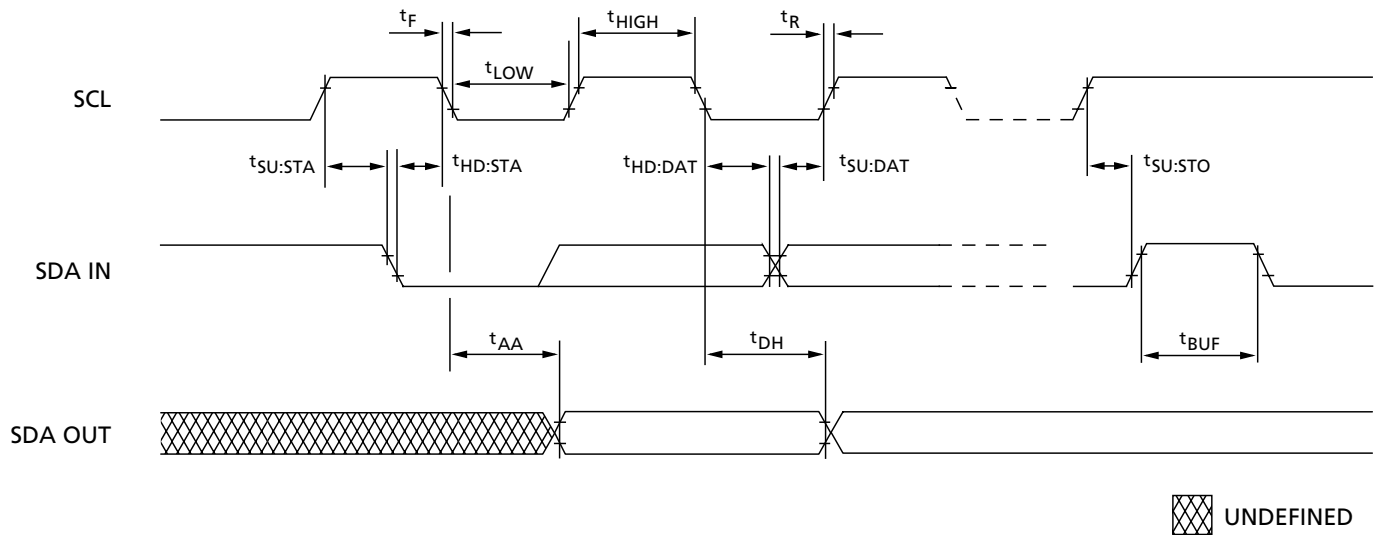

Table 21: Serial Presence-Detect EEPROM DC Operating Conditions

 All voltages referenced to V_{SS}; V_{DDSPD} = +2.3V to +3.6V

PARAMETER/CONDITION	SYMBOL	MIN	MAX	UNITS
SUPPLY VOLTAGE	V _{DDSPD}	2.3	3.6	V
INPUT HIGH VOLTAGE: Logic 1; All inputs	V _{IH}	V _{DD} x 0.7	V _{DD} + 0.5	V
INPUT LOW VOLTAGE: Logic 0; All inputs	V _{IL}	-1	V _{DD} x 0.3	V
OUTPUT LOW VOLTAGE: I _{OUT} = 3mA	V _{OL}	-	0.4	V
INPUT LEAKAGE CURRENT: V _{IN} = GND to V _{DD}	I _{LI}	-	10	μA
OUTPUT LEAKAGE CURRENT: V _{OUT} = GND to V _{DD}	I _{LO}	-	10	μA
STANDBY CURRENT: SCL = SDA = V _{DD} - 0.3V; All other inputs = V _{SS} or V _{DD}	I _{SB}	-	30	μA
POWER SUPPLY CURRENT: SCL clock frequency = 100 KHz	I _{CC}	-	2	mA

Table 22: Serial Presence-Detect EEPROM AC Operating Conditions

 All voltages referenced to V_{SS}; V_{DDSPD} = +2.3V to +3.6V

PARAMETER/CONDITION	SYMBOL	MIN	MAX	UNITS	NOTES
SCL LOW to SDA data-out valid	^t AA	0.2	0.9	μs	1
Time the bus must be free before a new transition can start	^t BUF	1.3		μs	
Data-out hold time	^t DH	200		ns	
SDA and SCL fall time	^t F		300	ns	2
Data-in hold time	^t HD:DAT	0		μs	
Start condition hold time	^t HD:STA	0.6		μs	
Clock HIGH period	^t HIGH	0.6		μs	
Noise suppression time constant at SCL, SDA inputs	^t I		50	ns	
Clock LOW period	^t LOW	1.3		μs	
SDA and SCL rise time	^t R		0.3	μs	2
SCL clock frequency	^f SCL		400	KHz	
Data-in setup time	^t SU:DAT	100		ns	
Start condition setup time	^t SU:STA	0.6		μs	3
Stop condition setup time	^t SU:STO	0.6		μs	
WRITE cycle time	^t WRC		10	ms	4

NOTE:

1. To avoid spurious START and STOP conditions, a minimum delay is placed between SCL = 1 and the falling or rising edge of SDA.
2. This parameter is sampled.
3. For a reSTART condition, or following a WRITE cycle.
4. The SPD EEPROM WRITE cycle time (^tWRC) is the time from a valid stop condition of a write sequence to the end of the EEPROM internal erase/program cycle. During the WRITE cycle, the EEPROM bus interface circuit is disabled, SDA remains HIGH due to pull-up resistor, and the EEPROM does not respond to its slave address.



Table 23: Serial Presence-Detect Matrix – 256MB, 512MB, and 1GB

"1"/"0": Serial Data, "driven to HIGH"/"driven to LOW"; notes appear on page 35

BYTE	DESCRIPTION	ENTRY (VERSION)	MT18VDDT3272	MT18VDDT6472	MT18VDDT12872
0	Number of SPD Bytes Used by Micron	128	80	80	80
1	Total Number of Bytes in SPD Device	256	08	08	08
2	Fundamental Memory Type	SDRAM DDR	07	07	07
3	Number of Row Addresses on Assembly	12 or 13	0C	0D	0D
4	Number of Column Addresses on Assembly	11 or 12	0B	0B	0C
5	Number of Physical Ranks on DIMM	1	01	01	01
6	Module Data Width	72	48	48	48
7	Module Data Width (Continued)	0	00	00	00
8	Module Voltage Interface Levels	SSTL 2.5V	04	04	04
9	SDRAM Cycle Time, ^t CK, (CAS Latency = 2.5) (See note 1)	7ns (-262/-26A) 7.5ns (-265) 8ns (-202)	70 75 80	70 75 80	70 75 80
10	SDRAM Access from Clock, (^t AC) (CAS Latency = 2.5)	0.75ns (-262/-26A/-265) 0.8ns (-202)	75 80	75 80	75 80
11	Module Configuration Type	ECC	02	02	02
12	Refresh Rate/Type	15.62μs, 7.81μs/SELF	80	82	82
13	SDRAM Device Width (Primary SDRAM)	8	04	04	04
14	Error-checking SDRAM Data Width	8	04	04	04
15	Minimum Clock Delay, Back-to-Back Random Column Access	1 clock	01	01	01
16	Burst Lengths Supported	2, 4, 8	0E	0E	0E
17	Number of Banks on SDRAM Device	4	04	04	04
18	CAS Latencies Supported	2, 2.5	0C	0C	0C
19	CS Latency	0	01	01	01
20	WE Latency	1	02	02	02
21	SDRAM Module Attributes	Registered/Diff. Clock	26	26	26
22	SDRAM Device Attributes: General	Fast/Concurrent AP	C0	C0	C0
23	SDRAM Cycle Time, ^t CK (CAS Latency = 2)	7.5ns (-262/-26A) 10ns (-265/-202)	75 A0	75 A0	75 A0
24	SDRAM Access from CK, ^t AC (CAS Latency = 2)	0.75ns (-262/-26A/-265) 0.8ns (-202)	75 80	75 80	75 80
25	SDRAM Cycle Time, ^t CK (CAS Latency = 1.5)	N/A	00	00	00
26	SDRAM Access from CK, ^t AC (CAS Latency = 1.5)	N/A	00	00	00
27	Minimum Row Precharge Time, ^t RP	15ns (-262) 20ns (-26A/-265/-202)	3C 50	3C 50	3C 50
28	Minimum Row Active to Row Active, ^t RRD	15ns (-262/-26A/-265/-202)	3C	3C	3C



Table 23: Serial Presence-Detect Matrix – 256MB, 512MB, and 1GB (Continued)

"1"/"0": Serial Data, "driven to HIGH"/"driven to LOW"; notes appear on page 35

BYTE	DESCRIPTION	ENTRY (VERSION)	MT18VDDT3272	MT18VDDT6472	MT18VDDT12872
29	Minimum RAS# to CAS# Delay, ^t RCD	15ns (-262) 20ns (-26A/-265/-202)	3C 50	3C 50	3C 50
30	Minimum RAS# Pulse Width, ^t RAS (Note 2)	45ns (-262/-26A/-265) 40ns (-202)	2D 28	2D 28	2D 28
31	Module Rank Density	128MB, 256MB, 512MB	40	80	01
32	Address and Command Setup Time, ^t IS (See note 3)	1ns (262/-26A/-265) 1.1ns (-202)	A0 B0	A0 B0	A0 B0
33	Address and Command Hold Time, ^t IH (See note 3)	1ns (-262/-26A/-265) 1.1ns (-202)	A0 B0	A0 B0	A0 B0
34	Data/Data Mask Input Setup Time, ^t DS	0.50ns (-262/-26A/-265) 0.6ns (-202)	50 60	50 60	50 60
35	Data/Data Mask Input Hold Time, ^t DH	0.50ns (-262/-26A/-265) 0.6ns (-202)	50 60	50 60	50 60
36-40	Reserved		00	00	00
41	Min Active Auto Refresh Time, ^t RC	60ns (-262) 65ns (-26A/-265) 70ns (-202)	3C 41 46	3C 41 46	3C 41 46
42	Minimum Auto Refresh to Active/ Auto Refresh Command Period, ^t RFC	75ns (-262/-26A/-265) 80ns (-202)	4B 50	4B 50	4B 50
43	SDRAM Device Max Cycle Time, ^t CKMAX	13ns (-262/-26A/-265/-202)	34	34	34
44	SDRAM Device Max DQS-DQ Skew Time, ^t DQSQ	0.5ns (-262/-26A/-265) 0.6ns (-202)	32 3C	32 3C	32 3C
45	SDRAM Device Max Read Data Hold Skew Factor, ^t QHS	0.75ns (-262/-26A/-265) 1.0ns (-202)	75 A0	75 A0	75 A0
46-61	Reserved		00	00	00
47	DIMM Height		10/01	10/01	10/01
46-61	Reserved		00	00	00
62	SPD Revision	Release 1.0	10	10	10
63	Checksum for Bytes 0-62 (Standard/Low-profile)	-262 -26A -265 -202	D7/C8 04/F5 34/25 CF/C0	1A/0B 47/38 77/68 12/03	9C/8D C9/BA F9/EA 94/85
64	Manufacturer's JEDEC ID Code	MICRON	2C	2C	2C
65-71	Manufacturer's JEDEC ID Code	(Continued)	FF	FF	FF
72	Manufacturing Location	01-12	01-0C	01-0C	01-0C
73-90	Module Part Number (ASCII)		Variable Data	Variable Data	Variable Data
91	PCB Identification Code	1-9	01-09	01-09	01-09
92	Identification Code (Continued)	0	00	00	00
93	Year of Manufacture in BCD		Variable Data	Variable Data	Variable Data



Table 23: Serial Presence-Detect Matrix – 256MB, 512MB, and 1GB (Continued)

"1"/"0": Serial Data, "driven to HIGH"/"driven to LOW"; notes appear on page 35

BYTE	DESCRIPTION	ENTRY (VERSION)	MT18VDDT3272	MT18VDDT6472	MT18VDDT12872
94	Week of Manufacture in BCD		Variable Data	Variable Data	Variable Data
95-98	Module Serial Number		Variable Data	Variable Data	Variable Data
99-127	Manufacturer-specific Data (RSVD)		–	–	–

NOTE:

1. Value for -262 and -26A t_{CK} set to 7ns (0x70) for optimum BIOS compatibility. Actual device spec. vaule is 7.5ns.
2. The value of t_{RAS} used for -262/-26A/-265 modules is calculated from $t_{RC} - t_{RP}$. Actual device spec value is 40 ns.
3. The JEDEC SPD specification allows fast or slow slew rate values for these bytes. The worst-case (slow slew rate) value is represented here. Systems requiring the fast slew rate setup and hold values are supported, provided the faster minimum slew rate is met.



Table 24: Serial Presence-Detect Matrix – 2GB

"1"/"0": Serial Data, "driven to HIGH"/"driven to LOW"; notes appear on page 35

BYTE	DESCRIPTION	ENTRY (VERSION)	MT18VDDT25672
0	Number of SPD Bytes Used by Micron	128	80
1	Total Number of Bytes in SPD Device	256	08
2	Fundamental Memory Type	SDRAM DDR	07
3	Number of Row Addresses on Assembly	14	0E
4	Number of Column Addresses on Assembly	11	0C
5	Number of Physical Ranks on DIMM	2	01
6	Module Data Width	72	48
7	Module Data Width (Continued)	0	00
8	Module Voltage Interface Levels	SSTL 2.5V	04
9	SDRAM Cycle Time, ^t CK, (CAS Latency = 2.5) (See note 1)	7ns (-262/-26A) 7.5ns (-265) 8ns (-202)	70 75 80
10	SDRAM Access from Clock, ^t AC (CAS Latency = 2.5)	0.75ns (-262/-26A/-265) 0.8ns (-202)	75 80
11	Module Configuration Type	ECC	02
12	Refresh Rate/Type	7.8μs/SELF	82
13	SDRAM Device Width (Primary SDRAM)	8	04
14	Error-checking SDRAM Data Width	8	04
15	Minimum Clock Delay, Back-to-Back Random Column Access	1 clock	01
16	Burst Lengths Supported	2, 4, 8	0E
17	Number of Banks on SDRAM Device	4	04
18	CAS Latencies Supported	2, 2.5	0C
19	CS Latency	0	01
20	WE Latency	1	02
21	SDRAM Module Attributes	Unbuffered/Diff. Clock	26
22	SDRAM Device Attributes: General	Fast/Concurrent AP	C0
23	SDRAM Cycle Time, ^t CK (CAS Latency = 2)	7.5ns (-262/-26A) 10ns (-265/-202)	75 A0
24	SDRAM Access from CK, ^t AC (CAS Latency = 2)	0.75ns (-262/-26A/-265) 0.8ns (-202)	75 80
25	SDRAM Cycle Time, ^t CK (CAS Latency = 1.5)	N/A	00
26	SDRAM Access from CK, ^t AC (CAS Latency = 1.5)	N/A	00
27	Minimum Row Precharge Time, ^t RP	15ns (-262) 20ns (-26A/-265/-202)	3C 50
28	Minimum Row Active to Row Active, ^t RRD	15ns (-262/-26A/-265/-202)	3C
29	Minimum RAS# to CAS# Delay, ^t RCD	15ns (-262) 20ns (-26A/-265/-202)	3C 50
30	Minimum RAS# Pulse Width, ^t RAS (Note 2)	45ns (-262/-26A/-265) 40ns (-202)	2D 28
31	Module Rank Density	1GB	02
32	Address and Command Setup Time, ^t IS (See note 3)	1ns (262/-26A/-265) 1.1ns (-202)	A0 B0
33	Address and Command Hold Time, ^t IH (See note 3)	1ns (-262/-26A/-265) 1.1ns (-202)	A0 B0

Table 24: Serial Presence-Detect Matrix – 2GB (Continued)

"1"/"0": Serial Data, "driven to HIGH"/"driven to LOW"; notes appear on page 35

BYTE	DESCRIPTION	ENTRY (VERSION)	MT18VDDT25672
34	Data/Data Mask Input Setup Time, t_{DS}	0.50ns (-262/-26A/-265) 0.6ns (-202)	50 60
35	Data/Data Mask Input Hold Time, t_{DH}	0.6ns (-202)	50 60
36-40	Reserved		00
41	Min Active Auto Refresh Time, t_{RC}	60ns (-262) 65ns (-26A/-265) 70ns (-202)	3C 41 46
42	Minimum Auto Refresh to Active/Auto Refresh Command Period, t_{RFC}	120ns	78
43	SDRAM Device Max Cycle Time, t_{CKMAX}	13ns (-262/-26A/-265/-202)	34
44	SDRAM Device Max DQS-DQ Skew Time, t_{DQSQ}	0.5ns (-262/-26A/-265) 0.6ns (-202)	32 3C
45	SDRAM Device Max Read Data Hold Skew Factor, t_{QHS}	0.75ns (-262/-26A/-265) 1.0ns (-202)	75 A0
46-61	Reserved		00
47	DIMM Height	Standard/Low-Profile	10/01
46-61	Reserved		00
62	SPD Revision	Release 1.0	10
63	Checksum for Bytes 0-62 (Standard/Low-profile)	-262 -26A -265 -202	CB/BC F8/E9 28/19 BE/AF
64	Manufacturer's JEDEC ID Code	MICRON	2C
65-71	Manufacturer's JEDEC ID Code	(Continued)	FF
72	Manufacturing Location	01-12	01-0C
73-90	Module Part Number (ASCII)		Variable Data
91	PCB Identification Code	1-9	01-09
92	Identification Code (Continued)	0	00
93	Year of Manufacture in BCD		Variable Data
94	Week of Manufacture in BCD		Variable Data
95-98	Module Serial Number		Variable Data
99-127	Manufacturer-Specific Data (RSVD)		-

NOTE:

1. Value for -262 and -26A t_{CK} set to 7ns (0x70) for optimum BIOS compatibility. Actual device spec. value is 7.5ns.
2. The value of t_{RAS} used for -262/-26A/-265 modules is calculated from $t_{RC} - t_{RP}$. Actual device spec value is 40 ns.
3. The JEDEC SPD specification allows fast or slow slew rate values for these bytes. The worst-case (slow slew rate) value is represented here. Systems requiring the fast slew rate setup and hold values are supported, provided the faster minimum slew rate is met.

Figure 17: Standard PCB Dimensions

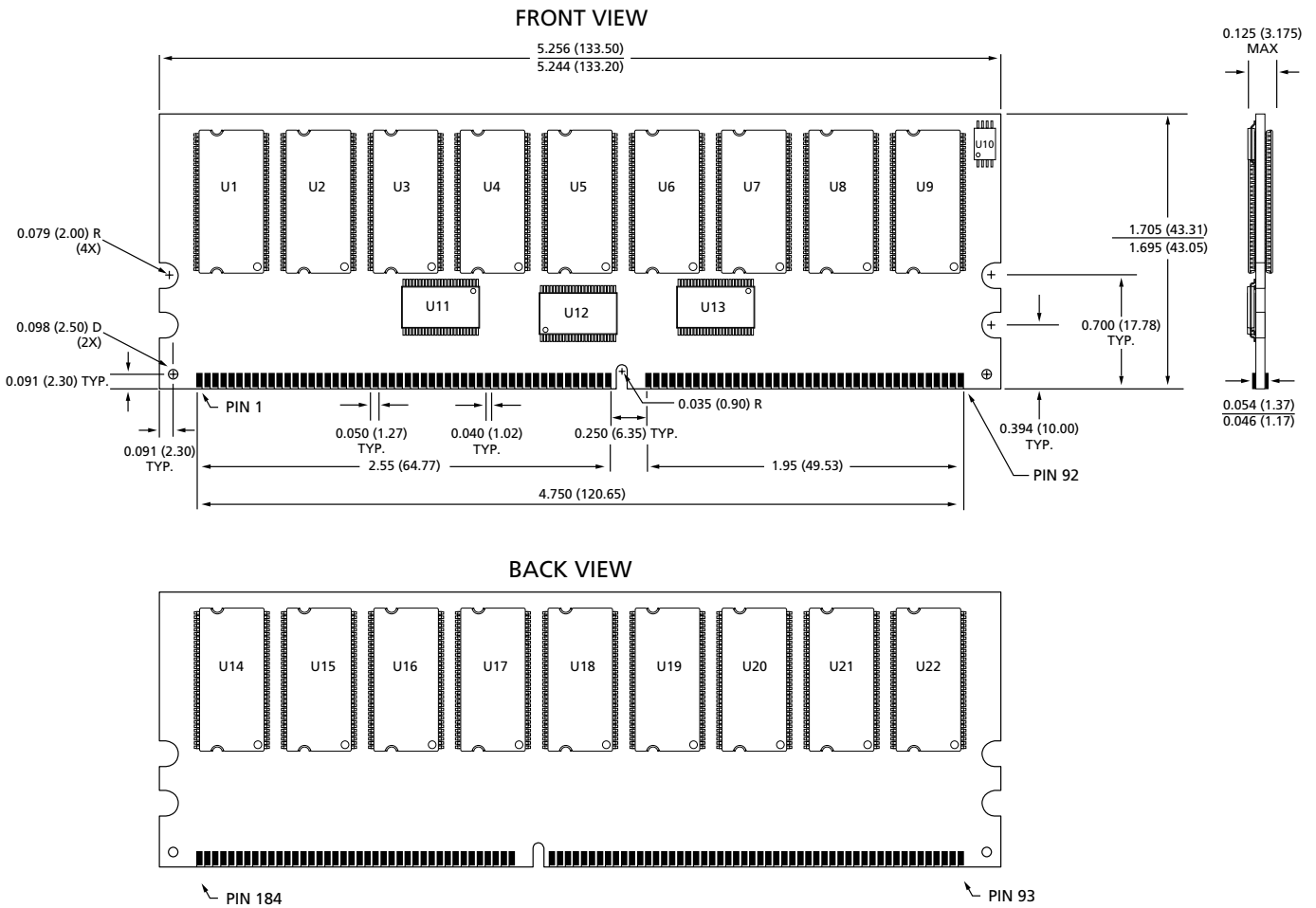

NOTE:

All dimensions in inches (millimeters); $\frac{\text{MAX}}{\text{MIN}}$ or typical where noted.

Figure 18: Low Profile PCB Dimensions

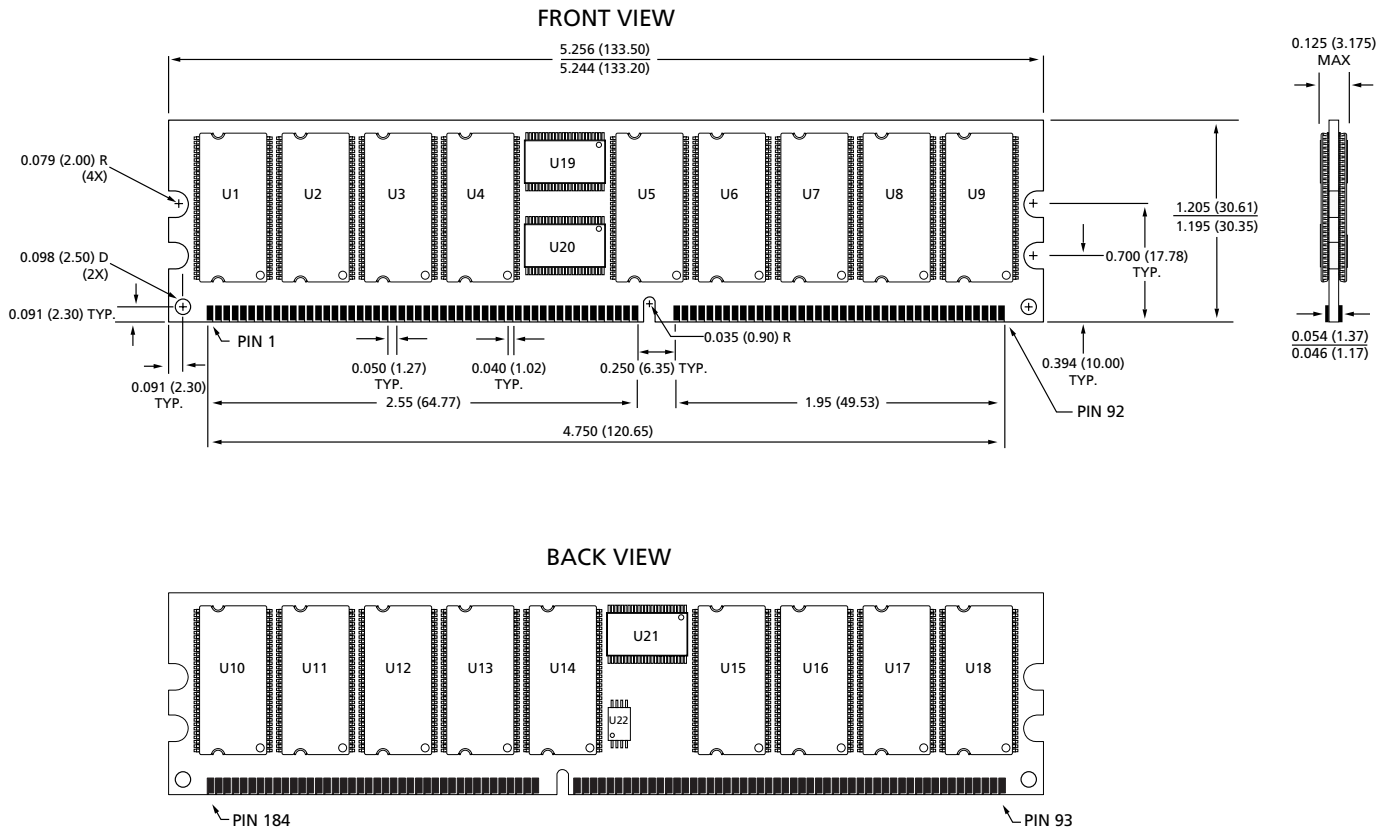

NOTE:

All dimensions in inches (millimeters); $\frac{MAX}{MIN}$ or typical where noted.

Data Sheet Designation

Released (No Mark): This data sheet contains minimum and maximum limits specified over the complete power supply and temperature range for production

devices. Although considered final, these specifications are subject to change, as further product development and data characterization sometimes occur.



8000 S. Federal Way, P.O. Box 6, Boise, ID 83707-0006, Tel: 208-368-3900

E-mail: prodmktg@micron.com, Internet: <http://www.micron.com>, Customer Comment Line: 800-932-4992

Micron, the M logo, and the Micron logo are trademarks and/or service marks of Micron Technology, Inc.

All other trademarks are the property of their respective owners.